

Technical Information

Proline Promag H 200

Electromagnetic flowmeter



The flowmeter for smallest flow rates with genuine loop-powered technology

Application

- The measuring principle is virtually independent of pressure, density, temperature and viscosity
- For the smallest flow quantities and demanding hygienic applications

Device properties

- Liner made of PFA
- Sensor housing made of stainless steel (3A, EHEDG)
- Wetted materials CIP, SIP cleanable
- Loop-powered technology
- Robust two-chamber housing
- Plant safety: worldwide approvals (SIL, Haz. area)

Your benefits

- Flexible installation concept – numerous hygienic process connections
- Energy-saving flow measurement – no pressure loss due to cross-section constriction
- Maintenance-free – no moving parts
- Convenient device wiring – separate connection compartment
- Safe operation – no need to open the device due to display with touch control, background lighting
- Integrated verification – Heartbeat Technology™

Table of contents

Document information	3	Process	30
Symbols used	3	Medium temperature range	30
Function and system design	3	Conductivity	31
Measuring principle	3	Pressure-temperature ratings	31
Measuring system	5	Pressure tightness	34
Safety	5	Flow limit	34
Input	5	Pressure loss	34
Measured variable	5	System pressure	35
Measuring range	5	Vibrations	35
Operable flow range	6	Mechanical construction	35
Output	6	Dimensions in SI units	35
Output signal	6	Dimensions in US units	48
Signal on alarm	7	Weight	56
Load	9	Measuring tube specification	57
Ex connection data	9	Materials	57
Low flow cut off	13	Fitted electrodes	58
Galvanic isolation	13	Process connections	58
Protocol-specific data	13	Surface roughness	59
Power supply	17	Operability	59
Terminal assignment	17	Operating concept	59
Pin assignment, device plug	18	Local operation	59
Supply voltage	18	Remote operation	60
Power consumption	18	Service interface	62
Current consumption	19	Certificates and approvals	63
Power supply failure	19	CE mark	63
Electrical connection	19	C-Tick symbol	63
Potential equalization	23	Ex approval	63
Terminals	24	Sanitary compatibility	64
Cable entries	24	Functional safety	64
Cable specification	24	HART certification	64
Overvoltage protection	25	FOUNDATION Fieldbus certification	64
Performance characteristics	25	Certification PROFIBUS	64
Reference operating conditions	25	Other standards and guidelines	64
Maximum measured error	25	Ordering information	65
Repeatability	26	Application packages	65
Influence of ambient temperature	26	Diagnostics functions	65
Installation	26	Heartbeat Technology	65
Mounting location	27	Accessories	66
Orientation	27	Device-specific accessories	66
Inlet and outlet runs	28	Communication-specific accessories	67
Adapters	28	Service-specific accessories	67
Special mounting instructions	29	System components	68
Environment	29	Documentation	68
Ambient temperature range	29	Standard documentation	68
Storage temperature	30	Supplementary device-dependent documentation	69
Degree of protection	30	Registered trademarks	69
Shock resistance	30		
Vibration resistance	30		
Mechanical load	30		
Electromagnetic compatibility (EMC)	30		

Document information

Symbols used

Electrical symbols

Symbol	Meaning	Symbol	Meaning
	Direct current		Alternating current
	Direct current and alternating current		Ground connection A grounded terminal which, as far as the operator is concerned, is grounded via a grounding system.
	Protective ground connection A terminal which must be connected to ground prior to establishing any other connections.		Equipotential connection A connection that has to be connected to the plant grounding system: This may be a potential equalization line or a star grounding system depending on national or company codes of practice.

Symbols for certain types of information

Symbol	Meaning
	Permitted Procedures, processes or actions that are permitted.
	Preferred Procedures, processes or actions that are preferred.
	Forbidden Procedures, processes or actions that are forbidden.
	Tip Indicates additional information.
	Reference to documentation
	Reference to page
	Reference to graphic
	Visual inspection

Symbols in graphics

Symbol	Meaning	Symbol	Meaning
1, 2, 3,...	Item numbers		Series of steps
A, B, C, ...	Views	A-A, B-B, C-C, ...	Sections
	Hazardous area		Safe area (non-hazardous area)
	Flow direction		

Function and system design

Measuring principle

Following *Faraday's law of magnetic induction*, a voltage is induced in a conductor moving through a magnetic field.

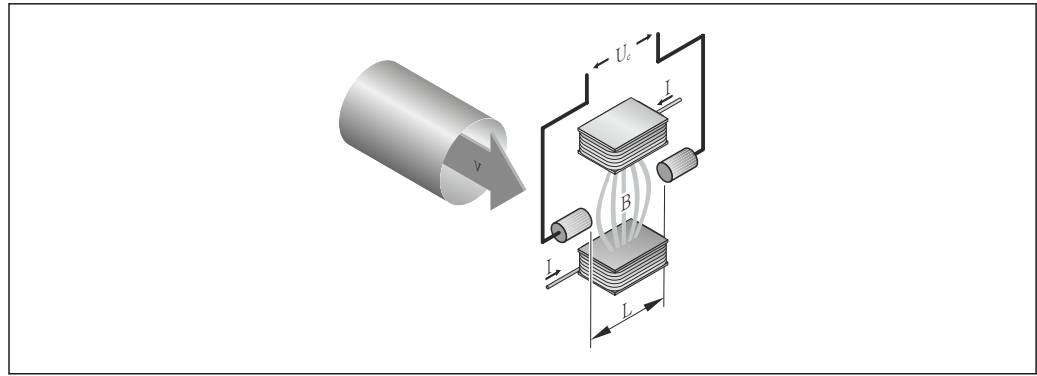

U_e Induced voltage
 B Magnetic induction (magnetic field)
 L Electrode spacing
 I Current
 v Flow velocity

In the electromagnetic measuring principle, the flowing medium is the moving conductor. The voltage induced (U_e) is proportional to the flow velocity (v) and is supplied to the amplifier by means of two measuring electrodes. The flow volume (Q) is calculated via the pipe cross-section (A). The DC magnetic field is created through a switched direct current of alternating polarity.

Formulae for calculation

- Induced voltage $U_e = B \cdot L \cdot v$
- Volume flow $Q = A \cdot v$

Measuring system

The device consists of a transmitter and a sensor.
 The device is available as a compact version:
 The transmitter and sensor form a mechanical unit.

Transmitter

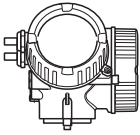
<p>Promag 200</p>  <p style="text-align: right; font-size: small;">A0013471</p>	<p>Materials: Aluminum, AlSi10Mg, coated</p> <p>Configuration:</p> <ul style="list-style-type: none"> ■ External operation via four-line, illuminated local display with touch control and guided menus ("Make-it-run" wizards) for applications ■ Via operating tools (e.g. FieldCare)
---	---

Sensor

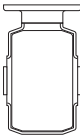
<p>Promag H</p>  <p style="text-align: right; font-size: small;">A0017702</p>	<p>Nominal diameter range: DN 2 to 25 (1/12 to 1")</p> <p>Materials:</p> <ul style="list-style-type: none"> ■ Sensor housing: stainless steel 1.4301 (304) ■ Measuring tubes: stainless steel, 1.4301 (304) ■ Liner: PFA (USP Class VI; FDA 21 CFR 177.1550; 3A) ■ Electrodes: stainless steel 1.4435 (F316L); Alloy C22, 2.4602 (UNS N06022); tantalum; platinum ■ Process connections: stainless steel, 1.4404 (F316L); PVDF; PVC adhesive sleeve ■ Seals: EPDM, FKM, Kalrez ■ Grounding rings (only for DN 02 to 25 (1/12 to 1")): stainless steel, 1.4435 (F316L); Alloy C22, 2.4602 (UNS N06022); tantalum
---	--

Safety

IT security

We only provide a warranty if the device is installed and used as described in the Operating Instructions. The device is equipped with security mechanisms to protect it against any inadvertent changes to the device settings.

IT security measures in line with operators' security standards and designed to provide additional protection for the device and device data transfer must be implemented by the operators themselves.

Input

Measured variable

Direct measured variables

Volume flow (proportional to induced voltage)

Calculated measured variables

Mass flow

Measuring range

Typically $v = 0.01$ to 10 m/s (0.03 to 33 ft/s) with the specified accuracy



Flow characteristic values in SI units

Nominal diameter		Recommended flow	Factory settings		
			Full scale value current output	Pulse value	Low flow cut off
[mm]	[in]	Min./max. full scale value ($v \sim 0.3/10$ m/s)	($v \sim 2.5$ m/s)	(~ 2 pulse/s)	($v \sim 0.04$ m/s)
		[dm ³ /min]	[dm ³ /min]	[dm ³]	[dm ³ /min]
2	1/12	0.06 to 1.8	0,5	0.005	0,01
4	1/8	0.25 to 7	2	0.025	0,05

Nominal diameter		Recommended flow Min./max. full scale value (v ~ 0.3/10 m/s) [dm ³ /min]	Factory settings		
[mm]	[in]		Full scale value current output (v ~ 2.5 m/s) [dm ³ /min]	Pulse value (~ 2 pulse/s) [dm ³]	Low flow cut off (v ~ 0.04 m/s) [dm ³ /min]
8	3/8	1 to 30	8	0.1	0,1
15	½	4 to 100	25	0.2	0,5
25	1	9 to 300	75	0.5	1

Flow characteristic values in US units

Nominal diameter		Recommended flow Min./max. full scale value (v ~ 0.3/10 m/s) [gal/min]	Factory settings		
[in]	[mm]		Full scale value current output (v ~ 2.5 m/s) [gal/min]	Pulse value (~ 2 pulse/s) [gal]	Low flow cut off (v ~ 0.04 m/s) [gal/min]
1/12	2	0.015 to 0.5	0,1	0,001	0,002
1/8	4	0.07 to 2	0,5	0,005	0,008
3/8	8	0.25 to 8	2	0,02	0,025
½	15	1 to 27	6	0,05	0,1
1	25	2.5 to 80	18	0,2	0,25

 To calculate the measuring range, use the *Applicator* sizing tool →  67

Recommended measuring range

"Flow limit" section →  34

Operable flow range

Over 1000 : 1



Output

Output signal

Current output

Current output	4-20 mA HART (passive)
Resolution	< 1 µA
Damping	Adjustable: 0.0 to 999.9 s
Assignable measured variables	<ul style="list-style-type: none"> ▪ Volume flow ▪ Mass flow

Pulse/frequency/switch output

Function	Can be set to pulse, frequency or switch output
Version	Passive, open collector
Maximum input values	<ul style="list-style-type: none"> ▪ DC 35 V ▪ 50 mA  For information on the Ex connection values →  9

Voltage drop	<ul style="list-style-type: none"> ▪ For ≤ 2 mA: 2 V ▪ For 10 mA: 8 V
Residual current	≤ 0.05 mA
Pulse output	
Pulse width	Adjustable: 5 to 2 000 ms
Maximum pulse rate	100 Impulse/s
Pulse value	Adjustable
Assignable measured variables	<ul style="list-style-type: none"> ▪ Volume flow ▪ Mass flow
Frequency output	
Output frequency	Adjustable: 0 to 1 000 Hz
Damping	Adjustable: 0 to 999 s
Pulse/pause ratio	1:1
Assignable measured variables	<ul style="list-style-type: none"> ▪ Volume flow ▪ Mass flow
Switch output	
Switching behavior	Binary, conductive or non-conductive
Switching delay	Adjustable: 0 to 100 s
Number of switching cycles	Unlimited
Assignable functions	<ul style="list-style-type: none"> ▪ Off ▪ On ▪ Diagnostic behavior ▪ Limit value <ul style="list-style-type: none"> - Volume flow - Mass flow ▪ Flow direction monitoring ▪ Status <ul style="list-style-type: none"> - Empty pipe detection - Low flow cut off

FOUNDATION Fieldbus

Signal encoding	Manchester Bus Powered (MBP)
Data transfer	31.25 KBit/s, Voltage mode

PROFIBUS PA

Signal encoding	Manchester Bus Powered (MBP)
Data transfer	31.25 KBit/s, Voltage mode

Signal on alarm

Depending on the interface, failure information is displayed as follows:

Current output

HART

Device diagnostics	Device condition can be read out via HART Command 48
---------------------------	--

Pulse/frequency/switch output*Pulse output*

Failure mode	Choose from: <ul style="list-style-type: none"> ▪ Actual value ▪ No pulses
---------------------	--

Frequency output

Failure mode	Choose from: <ul style="list-style-type: none"> ▪ Actual value ▪ 0 Hz ▪ Defined value: 0 to 1250 Hz
---------------------	--

Switch output

Failure mode	Choose from: <ul style="list-style-type: none"> ▪ Current status ▪ Open ▪ Closed
---------------------	---

FOUNDATION Fieldbus

Status and alarm messages	Diagnostics in accordance with FF-912
Error current FDE (Fault Disconnection Electronic)	0 mA

PROFIBUS PA

Status and alarm messages	Diagnostics in accordance with PROFIBUS PA Profile 3.02
Error current FDE (Fault Disconnection Electronic)	0 mA

Local display

Plain text display	With information on cause and remedial measures
Backlight	Additionally for device version with SD03 local display: red lighting indicates a device error.

 Status signal as per NAMUR recommendation NE 107

Operating tool

- Via digital communication:
 - HART protocol
 - FOUNDATION Fieldbus
 - PROFIBUS PA
- Via service interface

Plain text display	With information on cause and remedial measures
---------------------------	---

 Additional information on remote operation →  60

Load

Load for current output: 0 to 500 Ω, depending on the external supply voltage of the power supply unit

Calculation of the maximum load

Depending on the supply voltage of the power supply unit (U_S), the maximum load (R_B) including line resistance must be observed to ensure adequate terminal voltage at the device. In doing so, observe the minimum terminal voltage

- For $U_S = 18$ to 18.9 V: $R_B \leq (U_S - 18 \text{ V}): 0.0036 \text{ A}$
- For $U_S = 18.9$ to 24.5 V: $R_B \leq (U_S - 13.5 \text{ V}): 0.022 \text{ A}$
- For $U_S = 24.5$ to 30 V: $R_B \leq 500 \Omega$

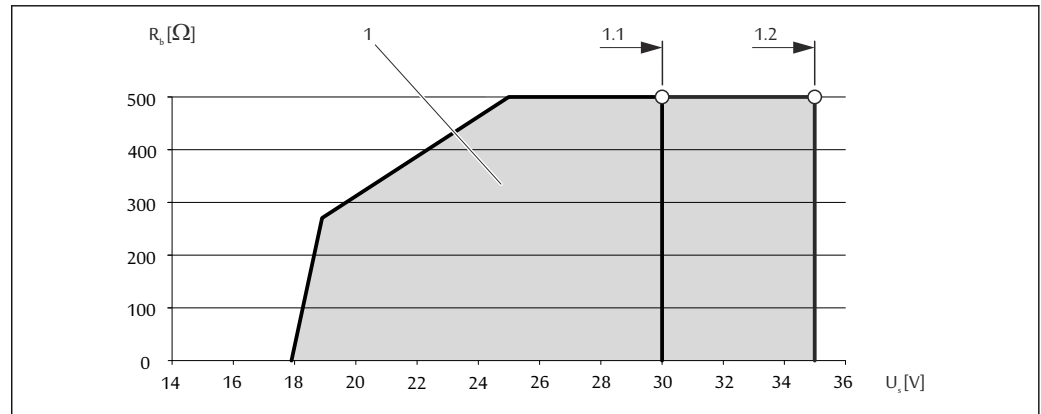

A0013563

- 1 Operating range
- 1.1 For order code for "Output", option A "4-20 mA HART"/option B "4-20 mA HART, pulse/frequency/switch output" with Ex i
- 1.2 For order code for "Output", option A "4-20 mA HART"/option B "4-20 mA HART, pulse/frequency/switch output" with non-Ex and Ex d

Sample calculation

Supply voltage of the power supply unit: $U_S = 19 \text{ V}$
 Maximum load: $R_B \leq (19 \text{ V} - 13.5 \text{ V}): 0.022 \text{ A} = 250 \Omega$

Ex connection data

Safety-related values

Type of protection Ex d

Order code for "Output"	Output type	Safety-related values
Option A	4-20mA HART	$U_{nom} = \text{DC } 35 \text{ V}$ $U_{max} = 250 \text{ V}$
Option B	4-20mA HART	$U_{nom} = \text{DC } 35 \text{ V}$ $U_{max} = 250 \text{ V}$
	Pulse/frequency/switch output	$U_{nom} = \text{DC } 35 \text{ V}$ $U_{max} = 250 \text{ V}$ $P_{max} = 1 \text{ W}^{1)}$
Option E	FOUNDATION Fieldbus	$U_{nom} = \text{DC } 32 \text{ V}$ $U_{max} = 250 \text{ V}$ $P_{max} = 0.88 \text{ W}$
	Pulse/frequency/switch output	$U_{nom} = \text{DC } 35 \text{ V}$ $U_{max} = 250 \text{ V}$ $P_{max} = 1 \text{ W}^{1)}$

Order code for "Output"	Output type	Safety-related values
Option G	PROFIBUS PA	$U_{nom} = DC 32 V$ $U_{max} = 250 V$ $P_{max} = 0.88 W$
	Pulse/frequency/switch output	$U_{nom} = DC 35 V$ $U_{max} = 250 V$ $P_{max} = 1 W^{1)}$

1) Internal circuit limited by $R_i = 760.5 \Omega$

Ex nA type of protection

Order code for "Output"	Output type	Safety-related values
Option A	4-20mA HART	$U_{nom} = DC 35 V$ $U_{max} = 250 V$
Option B	4-20mA HART	$U_{nom} = DC 35 V$ $U_{max} = 250 V$
	Pulse/frequency/switch output	$U_{nom} = DC 35 V$ $U_{max} = 250 V$ $P_{max} = 1 W^{1)}$
Option E	FOUNDATION Fieldbus	$U_{nom} = DC 32 V$ $U_{max} = 250 V$ $P_{max} = 0.88 W$
	Pulse/frequency/switch output	$U_{nom} = DC 35 V$ $U_{max} = 250 V$ $P_{max} = 1 W^{1)}$
Option G	PROFIBUS PA	$U_{nom} = DC 32 V$ $U_{max} = 250 V$ $P_{max} = 0.88 W$
	Pulse/frequency/switch output	$U_{nom} = DC 35 V$ $U_{max} = 250 V$ $P_{max} = 1 W^{1)}$

1) Internal circuit limited by $R_i = 760.5 \Omega$

Type of protection XP

Order code for "Output"	Output type	Safety-related values
Option A	4-20mA HART	$U_{nom} = DC 35 V$ $U_{max} = 250 V$
Option B	4-20mA HART	$U_{nom} = DC 35 V$ $U_{max} = 250 V$
	Pulse/frequency/switch output	$U_{nom} = DC 35 V$ $U_{max} = 250 V$ $P_{max} = 1 W^{1)}$
Option E	FOUNDATION Fieldbus	$U_{nom} = DC 32 V$ $U_{max} = 250 V$ $P_{max} = 0.88 W$
	Pulse/frequency/switch output	$U_{nom} = DC 35 V$ $U_{max} = 250 V$ $P_{max} = 1 W^{1)}$

Order code for "Output"	Output type	Safety-related values
Option G	PROFIBUS PA	U _{nom} = DC 32 V U _{max} = 250 V P _{max} = 0.88 W
	Pulse/frequency/switch output	U _{nom} = DC 35 V U _{max} = 250 V P _{max} = 1 W ¹⁾

1) Internal circuit limited by R_i = 760.5 Ω

Intrinsically safe values

Type of protection Ex ia

Order code for "Output"	Output type	Intrinsically safe values	
Option A	4-20mA HART	U _i = DC 30 V I _i = 300 mA P _i = 1 W L _i = 0 μH C _i = 5 nF	
Option B	4-20mA HART	U _i = DC 30 V I _i = 300 mA P _i = 1 W L _i = 0 μH C _i = 5 nF	
	Pulse/frequency/switch output	U _i = DC 30 V I _i = 300 mA P _i = 1 W L _i = 0 μH C _i = 6 nF	
Option E	FOUNDATION Fieldbus	STANDARD U _i = 30 V I _i = 300 mA P _i = 1.2 W L _i = 10 μH C _i = 5 nF	FISCO U _i = 17.5 V I _i = 550 mA P _i = 5.5 W L _i = 10 μH C _i = 5 nF
	Pulse/frequency/switch output	U _i = 30 V I _i = 300 mA P _i = 1 W L _i = 0 μH C _i = 6 nF	
Option G	PROFIBUS PA	STANDARD U _i = 30 V I _i = 300 mA P _i = 1.2 W L _i = 10 μH C _i = 5 nF	FISCO U _i = 17.5 V I _i = 550 mA P _i = 5.5 W L _i = 10 μH C _i = 5 nF
	Pulse/frequency/switch output	U _i = 30 V I _i = 300 mA P _i = 1 W L _i = 0 μH C _i = 6 nF	

Type of protection Ex ic

Order code for "Output"	Output type	Intrinsically safe values	
Option A	4-20mA HART	$U_i = DC 35 V$ $I_i = n.a.$ $P_i = 1 W$ $L_i = 0 \mu H$ $C_i = 5 nF$	
Option B	4-20mA HART	$U_i = DC 35 V$ $I_i = n.a.$ $P_i = 1 W$ $L_i = 0 \mu H$ $C_i = 5 nF$	
	Pulse/frequency/switch output	$U_i = DC 35 V$ $I_i = n.a.$ $P_i = 1 W$ $L_i = 0 \mu H$ $C_i = 6 nF$	
Option E	FOUNDATION Fieldbus	STANDARD $U_i = 32 V$ $I_i = 300 mA$ $P_i = n.a.$ $L_i = 10 \mu H$ $C_i = 5 nF$	FISCO $U_i = 17.5 V$ $I_i = n.a.$ $P_i = n.a.$ $L_i = 10 \mu H$ $C_i = 5 nF$
	Pulse/frequency/switch output	$U_i = 35 V$ $I_i = 300 mA$ $P_i = 1 W$ $L_i = 0 \mu H$ $C_i = 6 nF$	
Option G	PROFIBUS PA	STANDARD $U_i = 32 V$ $I_i = 300 mA$ $P_i = n.a.$ $L_i = 10 \mu H$ $C_i = 5 nF$	FISCO $U_i = 17.5 V$ $I_i = n.a.$ $P_i = n.a.$ $L_i = 10 \mu H$ $C_i = 5 nF$
	Pulse/frequency/switch output	$U_i = 35 V$ $I_i = 300 mA$ $P_i = 1 W$ $L_i = 0 \mu H$ $C_i = 6 nF$	

Type of protection IS

Order code for "Output"	Output type	Intrinsically safe values	
Option A	4-20mA HART	$U_i = DC 30 V$ $I_i = 300 mA$ $P_i = 1 W$ $L_i = 0 \mu H$ $C_i = 5 nF$	
Option B	4-20mA HART	$U_i = DC 30 V$ $I_i = 300 mA$ $P_i = 1 W$ $L_i = 0 \mu H$ $C_i = 5 nF$	
	Pulse/frequency/switch output	$U_i = DC 30 V$ $I_i = 300 mA$ $P_i = 1 W$ $L_i = 0 \mu H$ $C_i = 6 nF$	

Order code for "Output"	Output type	Intrinsically safe values	
Option E	FOUNDATION Fieldbus	STANDARD U _i = 30 V I _i = 300 mA P _i = 1.2 W L _i = 10 µH C _i = 5 nF	FISCO U _i = 17.5 V I _i = 550 mA P _i = 5.5 W L _i = 10 µH C _i = 5 nF
	Pulse/frequency/switch output	U _i = 30 V I _i = 300 mA P _i = 1 W L _i = 0 µH C _i = 6 nF	
Option G	PROFIBUS PA	STANDARD U _i = 30 V I _i = 300 mA P _i = 1.2 W L _i = 10 µH C _i = 5 nF	FISCO U _i = 17.5 V I _i = 550 mA P _i = 5.5 W L _i = 10 µH C _i = 5 nF
	Pulse/frequency/switch output	U _i = 30 V I _i = 300 mA P _i = 1 W L _i = 0 µH C _i = 6 nF	

Low flow cut off The switch points for low flow cut off are user-selectable.

Galvanic isolation All outputs are galvanically isolated from one another.

Protocol-specific data

HART

Manufacturer ID	0x11
Device type ID	0x48
HART protocol revision	7
Device description files (DTM, DD)	Information and files under: www.endress.com
HART load	<ul style="list-style-type: none"> ▪ Min. 250 Ω ▪ Max. 500 Ω
Dynamic variables	<p>Read out the dynamic variables: HART command 3 The measured variables can be freely assigned to the dynamic variables.</p> <p>Measured variables for PV (primary dynamic variable)</p> <ul style="list-style-type: none"> ▪ Off ▪ Volume flow ▪ Mass flow <p>Measured variables for SV, TV, QV (secondary, tertiary and quaternary dynamic variable)</p> <ul style="list-style-type: none"> ▪ Volume flow ▪ Mass flow ▪ Totalizer 1 ▪ Totalizer 2 ▪ Totalizer 3
Device variables	<p>Read out the device variables: HART command 9 The device variables are permanently assigned.</p>

FOUNDATION Fieldbus

Manufacturer ID	0x452B48
Ident number	0x1048
Device revision	1

DD revision	Information and files under:
CFF revision	<ul style="list-style-type: none"> ▪ www.endress.com ▪ www.fieldbus.org
Device Tester Version (ITK version)	6.1.1
ITK Test Campaign Number	IT094200
Link Master capability (LAS)	Yes
Choice of "Link Master" and "Basic Device"	Yes Factory setting: Basic Device
Node address	Factory setting: 247 (0xF7)
Supported functions	The following methods are supported: <ul style="list-style-type: none"> ▪ Restart ▪ ENP Restart ▪ Diagnostic
Virtual Communication Relationships (VCRs)	
Number of VCRs	44
Number of link objects in VFD	50
Permanent entries	1
Client VCRs	0
Server VCRs	10
Source VCRs	43
Sink VCRs	0
Subscriber VCRs	43
Publisher VCRs	43
Device Link Capabilities	
Slot time	4
Min. delay between PDU	8
Max. response delay	Min. 5

Transducer Blocks

Block	Contents	Output values
Setup Transducer Block (TRDSUP)	All parameters for standard commissioning.	No output values
Advanced Setup Transducer Block (TRDASUP)	All parameters for more accurate measurement configuration.	No output values
Display Transducer Block (TRDDISP)	Parameters for configuring the local display.	No output values
HistoROM Transducer Block (TRDHROM)	Parameters for using the HistoROM function.	No output values
Diagnostic Transducer Block (TRDDIAG)	Diagnostics information.	Process variables (AI Channel) <ul style="list-style-type: none"> ▪ Temperature (7) ▪ Volume flow (9) ▪ Mass flow (11)
Expert Configuration Transducer Block (TRDEXP)	Parameters that require the user to have in-depth knowledge of the operation of the device in order to configure the parameters appropriately.	No output values

Block	Contents	Output values
Expert Information Transducer Block (TRDEXPIN)	Parameters that provide information about the state of the device.	No output values
Service Sensor Transducer Block (TRDSRVS)	Parameters that can only be accessed by Endress+Hauser Service.	No output values
Service Information Transducer Block (TRDSRVIF)	Parameters that provide Endress+Hauser Service with information about the state of the device.	No output values
Total Inventory Counter Transducer Block (TRDTIC)	Parameters for configuring all the totalizers and the inventory counter.	Process variables (AI Channel) <ul style="list-style-type: none"> ■ Totalizer 1 (16) ■ Totalizer 2 (17) ■ Totalizer 3 (18)
Heartbeat Technology Transducer Block (TRDHBT)	Parameters for the configuration and comprehensive information about the results of the verification.	No output values
Heartbeat Results 1 Transducer Block (TRDHBTR1)	Information about the results of the verification.	No output values
Heartbeat Results 2 Transducer Block (TRDHBTR2)	Information about the results of the verification.	No output values
Heartbeat Results 3 Transducer Block (TRDHBTR3)	Information about the results of the verification.	No output values
Heartbeat Results 4 Transducer Block (TRDHBTR4)	Information about the results of the verification.	No output values

Function blocks

Block	Number of blocks	Contents	Process variables (Channel)
Resource Block (RB)	1	This Block (extended functionality) contains all the data that uniquely identify the device; it is the equivalent of an electronic nameplate for the device.	–
Analog Input Block (AI)	4	This Block (extended functionality) receives the measurement data provided by the Sensor Block (can be selected via a channel number) and makes the data available for other blocks at the output. Execution time: 25 ms	Process variables (AI Channel) <ul style="list-style-type: none"> ■ Temperature (7) ■ Volume flow (9) ■ Mass flow (11)
Discrete Input Block (DI)	2	This Block (standard functionality) receives a discrete value (e.g. indicator that measuring range has been exceeded) and makes the value available for other blocks at the output. Execution time: 19 ms	<ul style="list-style-type: none"> ■ Switch output state (101) ■ Empty pipe detection (102) ■ Low flow cut off (103) ■ Status verification (105)
PID Block (PID)	1	This Block (standard functionality) acts as a proportional-integral-differential controller and can be used universally for control in the field. It enables cascading and feedforward control. Execution time: 25 ms	–

Block	Number of blocks	Contents	Process variables (Channel)
Multiple Digital Output Block (MDO)	1	This Block (standard functionality) receives several discrete values and makes them available for other blocks at the output. Execution time: 19 ms	Channel_DO (122) <ul style="list-style-type: none"> ■ Value 1: Reset totalizer 1 ■ Value 2: Reset totalizer 2 ■ Value 3: Reset totalizer 3 ■ Value 4: Flow override ■ Value 5: Start heartbeat verification ■ Value 6: Status switch output ■ Value 7: Not assigned ■ Value 8: Not assigned
Integrator Block (IT)	1	This Block (standard functionality) integrates a measured variable over time or totalizes the pulses from a Pulse Input Block. The Block can be used as a totalizer that totalizes until a reset, or as a batch totalizer whereby the integrated value is compared against a target value generated before or during the control routine and generates a binary signal when the target value is reached. Execution time: 21 ms	–

PROFIBUS PA

Manufacturer ID	0x11
Ident number	0x1563
Profile version	3.02
Device description files (GSD, DTM, DD)	Information and files under: <ul style="list-style-type: none"> ■ www.endress.com ■ www.profibus.org
Output values (from measuring device to automation system)	Analog input 1 to 2 <ul style="list-style-type: none"> ■ Mass flow ■ Volume flow Digital input 1 to 2 <ul style="list-style-type: none"> ■ Empty pipe detection ■ Low flow cut off ■ Status switch output ■ Status verification Totalizer 1 to 3 <ul style="list-style-type: none"> ■ Mass flow ■ Volume flow ■ Corrected volume flow
Input values (from automation system to measuring device)	Digital output 1 to 3 (fixed assignment) <ul style="list-style-type: none"> ■ Digital output 1: switch positive zero return on/off ■ Digital output 2: switch switch output on/off ■ Digital output 3: start verification Totalizer 1 to 3 <ul style="list-style-type: none"> ■ Totalize ■ Reset and hold ■ Preset and hold ■ Operating mode configuration: <ul style="list-style-type: none"> – Net flow total – Forward flow total – Reverse flow total

Supported functions	<ul style="list-style-type: none"> ▪ Identification & Maintenance Simplest device identification on the part of the control system and nameplate ▪ PROFIBUS upload/download Reading and writing parameters is up to ten times faster with PROFIBUS upload/download ▪ Condensed status Simplest and self-explanatory diagnostic information by categorizing diagnostic messages that occur
Configuration of the device address	<ul style="list-style-type: none"> ▪ DIP switches on the I/O electronics module ▪ Local display ▪ via operating tools (e.g. FieldCare)

Power supply

Terminal assignment

Transmitter

Connection versions

<i>Maximum number of terminals, without integrated overvoltage protection</i>	<i>Maximum number of terminals, with integrated overvoltage protection</i>
<p>1 Output 1 (passive): supply voltage and signal transmission 2 Output 2 (passive): supply voltage and signal transmission 3 Ground terminal for cable shield</p>	

Order code for "Output"	Terminal numbers			
	Output 1		Output 2	
	1 (+)	2 (-)	3 (+)	4 (-)
Option A	4-20 mA HART (passive)		-	
Option B ¹⁾	4-20 mA HART (passive)		Pulse/frequency/switch output (passive)	
Option E ^{1) 2)}	FOUNDATION Fieldbus		Pulse/frequency/switch output (passive)	
Option G ^{1) 3)}	PROFIBUS PA		Pulse/frequency/switch output (passive)	

- 1) Output 1 must always be used; output 2 is optional.
- 2) FOUNDATION Fieldbus with integrated reverse polarity protection.
- 3) PROFIBUS PA with integrated reverse polarity protection.

Pin assignment, device plug PROFIBUS PA

Device plug for signal transmission (device side)

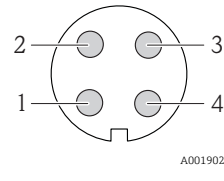
	Pin	Assignment		Coding	Plug/socket
	1	+	PROFIBUS PA +	A	Plug
	2		Grounding		
	3	-	PROFIBUS PA -		
4		Not assigned			

FOUNDATION Fieldbus

Device plug for signal transmission (device side)

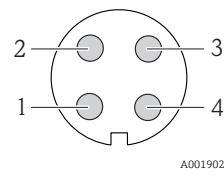

	Pin	Assignment		Coding	Plug/socket
	1	+	Signal +	A	Plug
	2	-	Signal -		
	3		Not assigned		
4		Grounding			

Supply voltage**Transmitter**

An external power supply is required for each output.

Order code for "Output"	Minimum terminal voltage	Maximum terminal voltage
Option A ^{1) 2)} : 4-20 mA HART	<ul style="list-style-type: none"> ▪ For 4 mA: ≥ DC 18 V ▪ For 20 mA: ≥ DC 14 V 	DC 35 V
Option B ^{1) 2)} : 4-20 mA HART, pulse/frequency/switch output	<ul style="list-style-type: none"> ▪ For 4 mA: ≥ DC 18 V ▪ For 20 mA: ≥ DC 14 V 	DC 35 V
Option E ³⁾ : FOUNDATION Fieldbus, pulse/frequency/switch output	≥ DC 9 V	DC 32 V
Option G ³⁾ : PROFIBUS PA, pulse/frequency/switch output	≥ DC 9 V	DC 32 V

- 1) External supply voltage of the power supply unit with load.
- 2) For device versions with SD03 local display: The terminal voltage must be increased by DC 2 V if backlighting is used.
- 3) For device version with SD03 local display: The terminal voltage must be increased by DC 0.5 V if backlighting is used.

 For information about the load see →  9

 Various power supply units can be ordered from Endress+Hauser: see "Accessories" section →  68

 For information on the Ex connection values →  9

Power consumption**Transmitter**

Order code for "Output"	Maximum power consumption
Option A : 4-20 mA HART	770 mW
Option B : 4-20 mA HART, pulse/frequency/switch output	<ul style="list-style-type: none"> ▪ Operation with output 1: 770 mW ▪ Operation with output 1 and 2: 2 770 mW

Order code for "Output"	Maximum power consumption
Option E : FOUNDATION Fieldbus, pulse/frequency/switch output	<ul style="list-style-type: none"> ■ Operation with output 1: 576 mW ■ Operation with output 1 and 2: 2 576 mW
Option G : PROFIBUS PA, pulse/frequency/switch output	<ul style="list-style-type: none"> ■ Operation with output 1: 512 mW ■ Operation with output 1 and 2: 2 512 mW

 For information on the Ex connection values →  9

Current consumption

Current output

For every 4-20 mA or 4-20 mA HART current output: 3.6 to 22.5 mA

 If the option **Defined value** is selected in the **Failure mode** parameter : 3.59 to 22.5 mA

PROFIBUS PA

16 mA

FOUNDATION Fieldbus

16 mA

Power supply failure

- Totalizers stop at the last value measured.
- Configuration is retained in the device memory (HistoROM).
- Error messages (incl. total operated hours) are stored.

Electrical connection

Connecting the transmitter

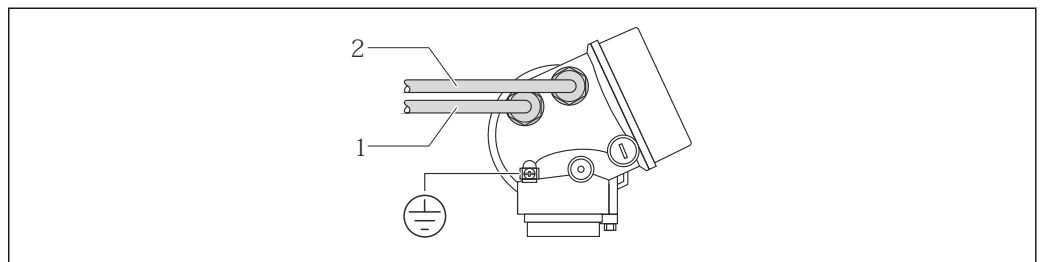

- 1 Cable entry for output 1
 2 Cable entry for output 2

A0015510

Connection examples

Current output 4-20 mA HART

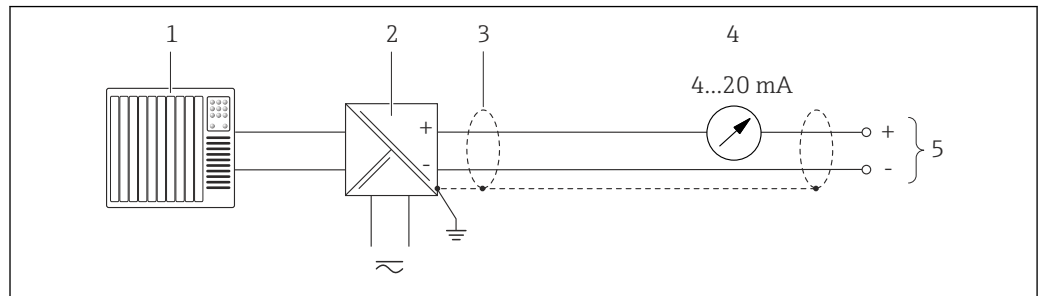

A0015511

1 Connection example for 4-20 mA HART current output (passive)

- 1 Automation system with current input (e.g. PLC)
- 2 Active barrier for power supply with integrated resistor for HART communication ($\geq 250 \Omega$) (e.g. RN221N)
Connection for HART operating devices \rightarrow 60
Observe the maximum load \rightarrow 9
- 3 Cable shield, observe cable specifications
- 4 Analog display unit: observe maximum load \rightarrow 9
- 5 Transmitter

Pulse/frequency output

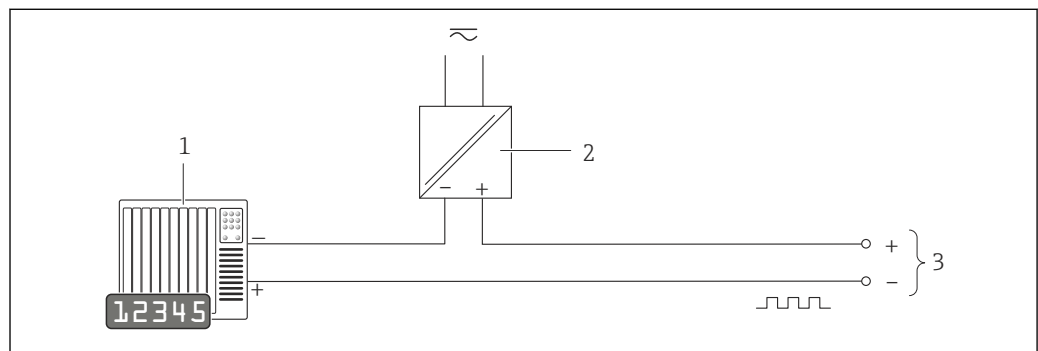

A0016801

2 Connection example for pulse/frequency output (passive)

- 1 Automation system with pulse/frequency input (e.g. PLC)
- 2 Power supply
- 3 Transmitter: observe input values \rightarrow 6

Switch output

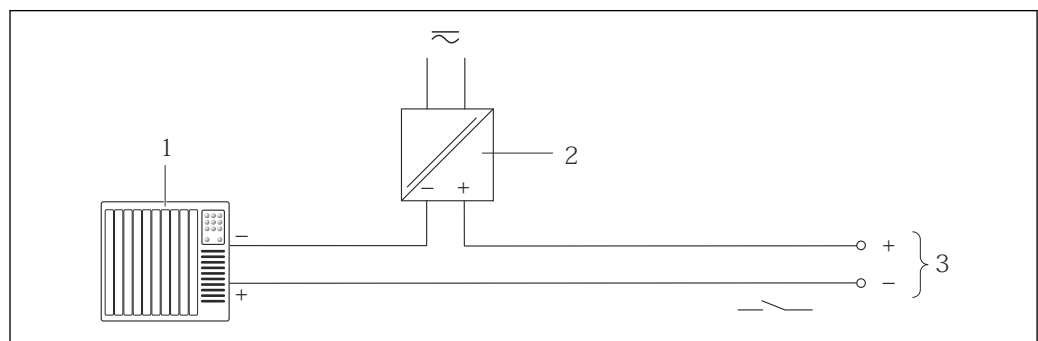

A0016802

3 Connection example for switch output (passive)

- 1 Automation system with switch input (e.g. PLC)
- 2 Power supply
- 3 Transmitter: observe input values

PROFIBUS-PA

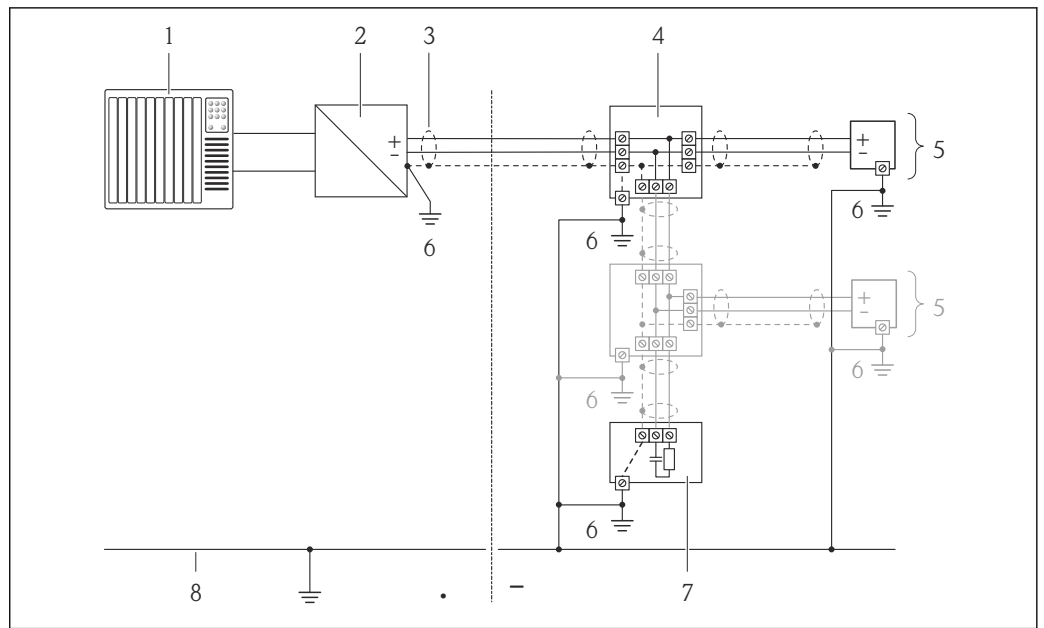

A0019004

4 Connection example for PROFIBUS-PA

- 1 Control system (e.g. PLC)
- 2 Segment coupler PROFIBUS DP/PA
- 3 Cable shield
- 4 T-box
- 5 Measuring device
- 6 Local grounding
- 7 Bus terminator
- 8 Potential matching line

FOUNDATION Fieldbus

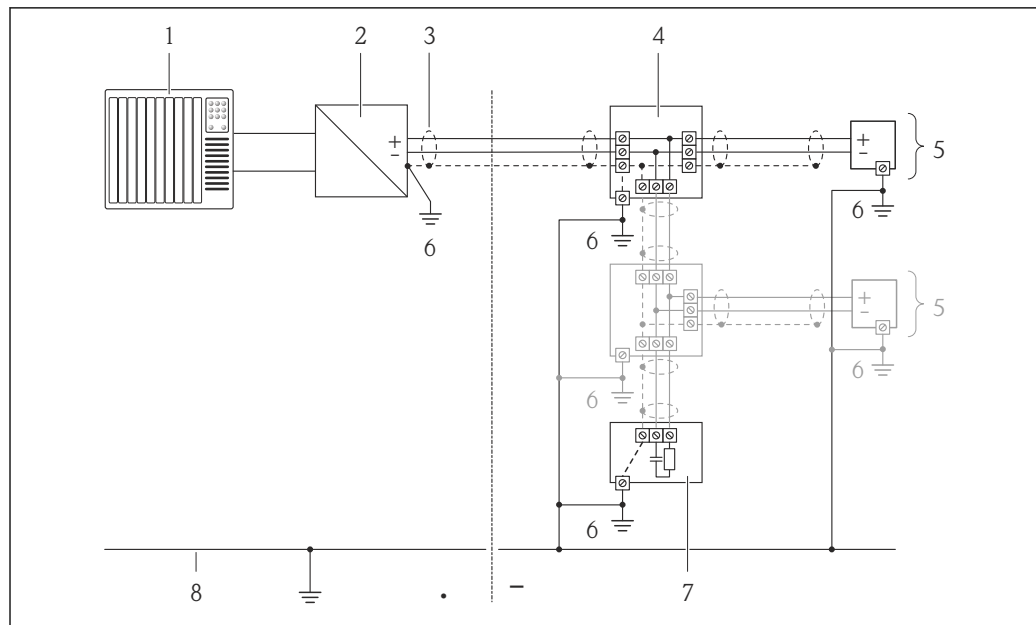

A0019004

5 Connection example for FOUNDATION Fieldbus

- 1 Control system (e.g. PLC)
- 2 Power Conditioner (FOUNDATION Fieldbus)
- 3 Cable shield
- 4 T-box
- 5 Measuring device
- 6 Local grounding
- 7 Bus terminator
- 8 Potential matching line

HART input

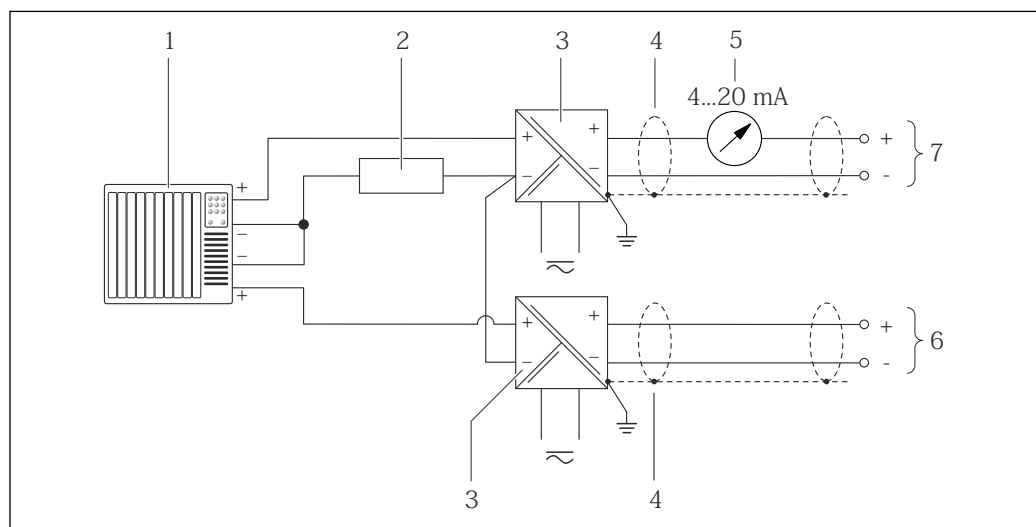

A0016029

6 Connection example for HART input with a common negative

- 1 Automation system with HART output (e.g. PLC)
- 2 Resistor for HART communication ($\geq 250 \Omega$): observe maximum load \rightarrow 9
- 3 Active barrier for power supply (e.g. RN221N)
- 4 Cable shield, observe cable specifications
- 5 Analog display unit: observe maximum load \rightarrow 9
- 6 Pressure transmitter (e.g. Cerabar M, Cerabar S): see requirements
- 7 Transmitter

Potential equalization

Requirements

Please consider the following to ensure correct measurement:

- Same electrical potential for the fluid and sensor
- Company-internal grounding concepts
- Pipe material and grounding

 For devices intended for use in hazardous locations, please observe the guidelines in the Ex documentation (XA).

Connection example, standard scenario

Metal process connections

Potential equalization is generally via the metal process connections that are in contact with the medium and mounted directly on the sensor. Therefore there is generally no need for additional potential equalization measures.

Connection example in special situations

Plastic process connections

In the case of plastic process connections, additional grounding rings or process connections with an integrated grounding electrode must be used to ensure potential matching between the sensor and the fluid. If there is no potential matching, this can affect the measuring accuracy or cause the destruction of the sensor as a result of the electrochemical decomposition of the electrodes.

Note the following when using grounding rings:

- Depending on the option ordered, plastic disks are used instead of grounding rings on some process connections. These plastic disks only act as "spacers" and do not have any potential matching function. Furthermore, they also perform a significant sealing function at the sensor/connection interface. Therefore, in the case of process connections without metal grounding rings, these plastic disks/seals should never be removed and should always be installed!
- Grounding rings can be ordered separately as an accessory from Endress+Hauser. When ordering make sure that the grounding rings are compatible with the material used for the electrodes, as otherwise there is the danger that the electrodes could be destroyed by electrochemical corrosion!
- Grounding rings, including seals, are mounted inside the process connections. Therefore the installation length is not affected.

Potential equalization via additional grounding ring

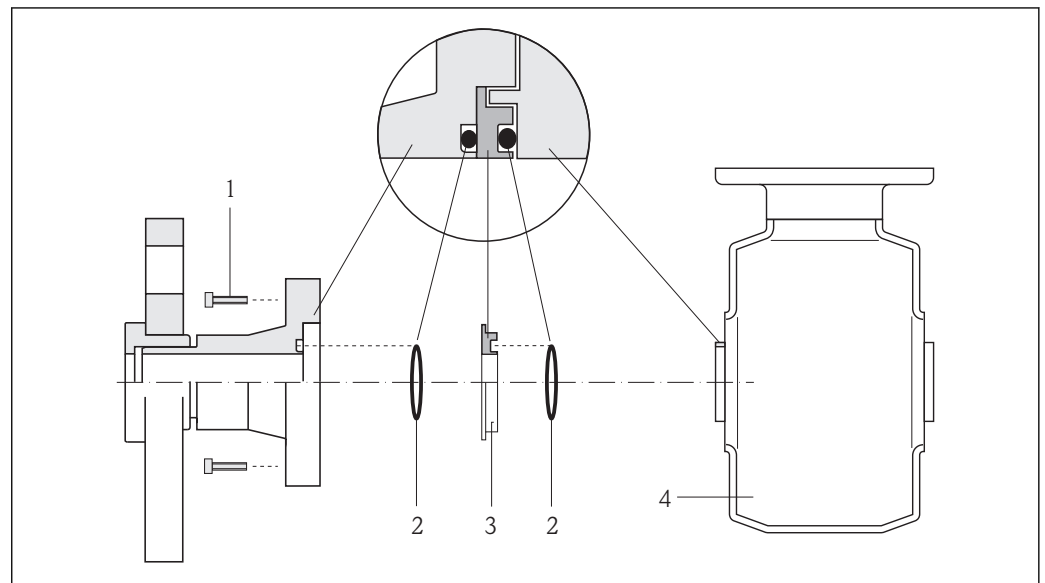

- 1 Hexagonal-headed bolts of process connection
- 2 O-ring seals
- 3 Plastic disk (spacer) or grounding ring
- 4 Sensor

A0002651

Potential equalization via grounding electrodes on process connection

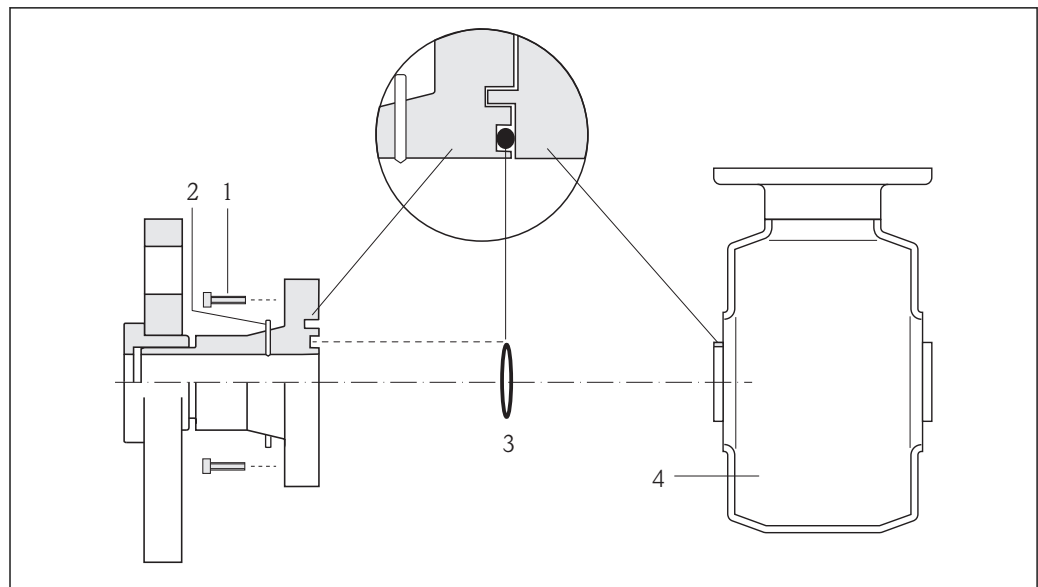

A0017295

- 1 Hexagonal-headed bolts of process connection
 2 Integrated grounding electrodes
 3 O-ring seal
 4 Sensor

Terminals

- For device version without integrated overvoltage protection: plug-in spring terminals for wire cross-sections 0.5 to 2.5 mm² (20 to 14 AWG)
- For device version with integrated overvoltage protection: screw terminals for wire cross-sections 0.2 to 2.5 mm² (24 to 14 AWG)

Cable entries

- Cable gland (not for Ex d): M20 × 1.5 with cable ϕ 6 to 12 mm (0.24 to 0.47 in)
- Thread for cable entry:
 - For non-Ex and Ex: NPT 1/2"
 - For non-Ex and Ex (not for CSA Ex d/XP): G 1/2"
 - For Ex d: M20 × 1.5

Cable specification**Permitted temperature range**

- -40 °C (-40 °F) to +80 °C (+176 °F)
- Minimum requirement: cable temperature range \geq ambient temperature +20 K

Signal cable*Current output*

For 4-20 mA HART: Shielded cable recommended. Observe grounding concept of the plant.

Pulse/frequency/switch output

Standard installation cable is sufficient.

FOUNDATION Fieldbus

Twisted, shielded two-wire cable.



For further information on planning and installing FOUNDATION Fieldbus networks see:

- Operating Instructions for "FOUNDATION Fieldbus Overview" (BA00013S)
- FOUNDATION Fieldbus Guideline
- IEC 61158-2 (MBP)

PROFIBUS PA

Twisted, shielded two-wire cable. Cable type A is recommended.



For further information on planning and installing PROFIBUS PA networks see:

- Operating Instructions "PROFIBUS DP/PA: Guidelines for planning and commissioning" (BA00034S)
- PNO Directive 2.092 "PROFIBUS PA User and Installation Guideline"
- IEC 61158-2 (MBP)

Overvoltage protection

The device can be ordered with integrated overvoltage protection for diverse approvals:
Order code for "Accessory mounted", option NA "Overvoltage protection"

Input voltage range	Values correspond to supply voltage specifications ¹⁾
Resistance per channel	2 · 0.5 Ω max
DC sparkover voltage	400 to 700 V
Trip surge voltage	< 800 V
Capacitance at 1 MHz	< 1.5 pF
Nominal discharge current (8/20 μs)	10 kA
Temperature range	-40 to +85 °C (-40 to +185 °F)

1) The voltage is reduced by the amount of the internal resistance $I_{min} \cdot R_i$



Depending on the temperature class, restrictions apply to the ambient temperature for device versions with overvoltage protection

Performance characteristics

Reference operating conditions

In accordance with DIN EN 29104

- Water, typically 15 to 45 °C (59 to 113 °F); 2 to 6 bar (29 to 87 psi)
- Data as indicated in the calibration protocol ±5 °C (±41 °F) and ±2 bar (±29 psi)
- Accuracy based on accredited calibration rigs traced to ISO 17025
- Medium temperature: +28 ± 2 °C (+82 ± 4 °F)
- Ambient temperature: +22 ± 2 °C (+72 ± 4 °F)
- Warm-up period: 30 min

Installation

- Inlet run > 10 × DN
- Outlet run > 5 × DN
- Sensor and transmitter grounded.
- The sensor is centered in the pipe.



To calculate the measuring range, use the *Applicator* sizing tool → 67

Maximum measured error

Error limits under reference operating conditions

o.r. = of reading

Volume flow

±0.5 % o.r. ± 2 mm/s (0.08 in/s)



Fluctuations in the supply voltage do not have any effect within the specified range.

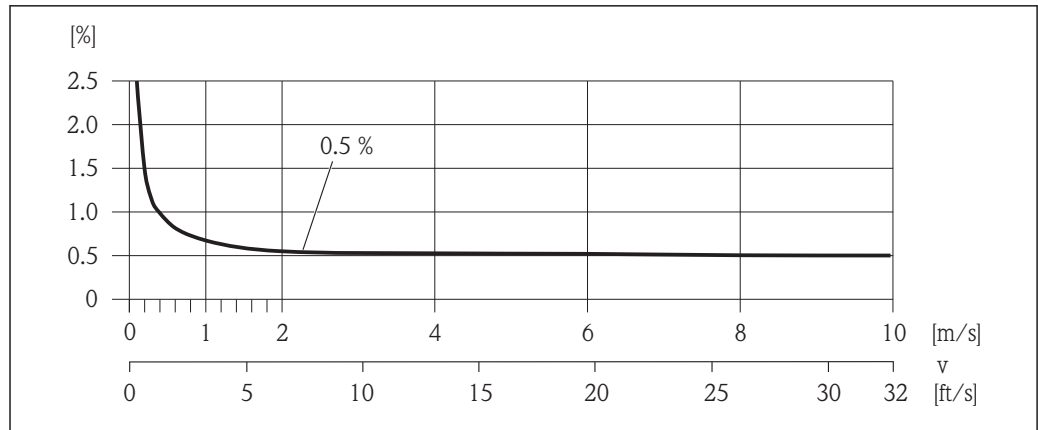

A0003200

7 Maximum measured error in % o.r.

Accuracy of outputs

The outputs have the following base accuracy specifications.

Current output

Accuracy	±10 µA
----------	--------

Pulse/frequency output

o.r. = of reading

Accuracy	Max. ±100 ppm o.r.
----------	--------------------

Repeatability

o.r. = of reading

Volume flow

Max. ±0.2 % o.r. ± 2 mm/s (0.08 in/s)

Influence of ambient temperature

Current output

o.r. = of reading

Additional error, in relation to the span of 16 mA:

Temperature coefficient at zero point (4 mA)	0.02 %/10 K
Temperature coefficient with span (20 mA)	0.05 %/10 K

Pulse/frequency output

o.r. = of reading

Temperature coefficient	Max. ±100 ppm o.r.
-------------------------	--------------------

Installation

No special measures such as supports are necessary. External forces are absorbed by the construction of the device.

Mounting location

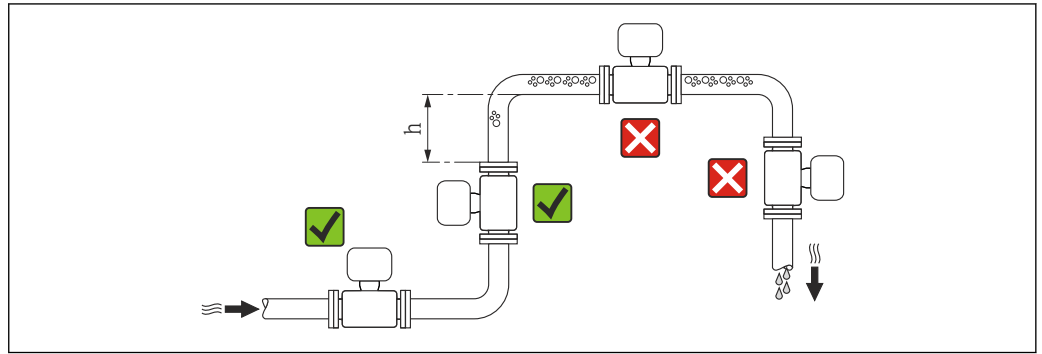

A0023343

Preferably install the sensor in an ascending pipe, and ensure a sufficient distance to the next pipe elbow: $h \geq 2 \times DN$

To prevent measuring errors arising from accumulation of gas bubbles in the measuring tube, avoid the following mounting locations in the pipe:

- Highest point of a pipeline.
- Directly upstream of a free pipe outlet in a down pipe.

Installation in down pipes

Install a siphon with a vent valve downstream of the sensor in down pipes whose length $h \geq 5 \text{ m}$ (16.4 ft). This precaution is to avoid low pressure and the consequent risk of damage to the measuring tube. This measure also prevents the system losing prime.

 For information on the liner's resistance to partial vacuum

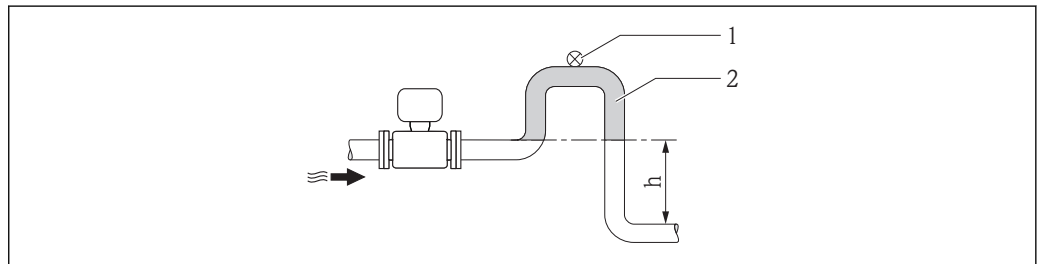

A0017064

 8 Installation in a down pipe

- 1 Vent valve
- 2 Pipe siphon
- h Length of down pipe

Installation in partially filled pipes

A partially filled pipe with a gradient necessitates a drain-type configuration. The empty pipe detection (EPD) function offers additional protection by detecting empty or partially filled pipes.

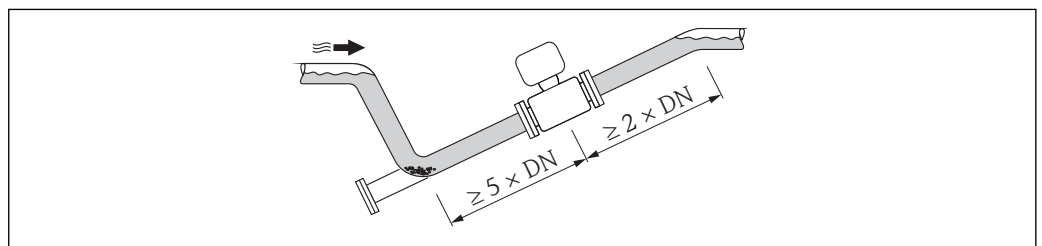

A0017063

Orientation

The direction of the arrow on the sensor nameplate helps you to install the sensor according to the flow direction (direction of medium flow through the piping).

An optimum orientation position helps avoid gas and air accumulations and deposits in the measuring tube.

The measuring device also offers the empty pipe detection function to detect partially filled measuring pipes in the event of outgassing fluids or variable process pressures.

Vertical

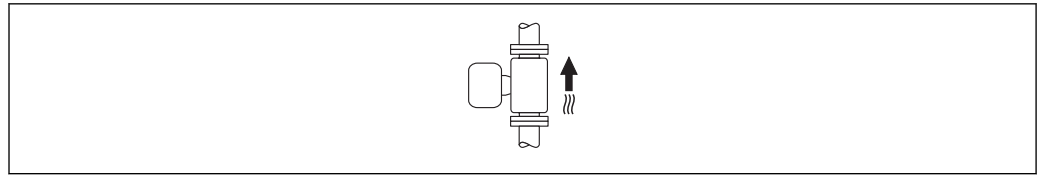

A0015591

Optimum for self-emptying pipe systems and for use in conjunction with empty pipe detection.

Horizontal

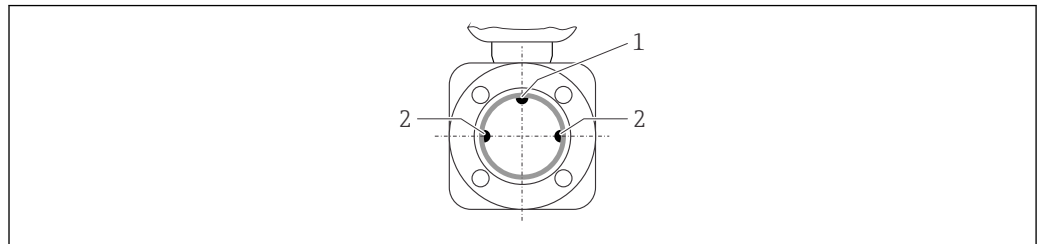

A0019602

- 1 EPD electrode for empty pipe detection
2 Measuring electrodes for signal detection

-  The measuring electrode plane must be horizontal. This prevents brief insulation of the two measuring electrodes by entrained air bubbles.
- Empty pipe detection only works if the transmitter housing is pointing upwards as otherwise there is no guarantee that the empty pipe detection function will actually respond to a partially filled or empty measuring tube.

Inlet and outlet runs

If possible, install the sensor upstream from fittings such as valves, T-pieces or elbows.

Observe the following inlet and outlet runs to comply with accuracy specifications:

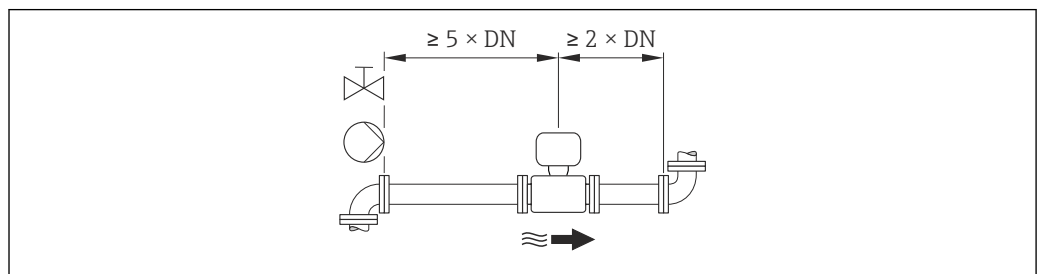

A0016275

Adapters

Suitable adapters to DIN EN 545 (double-flange reducers) can be used to install the sensor in larger-diameter pipes. The resultant increase in the rate of flow improves measuring accuracy with very slow-moving fluids.

The nomogram shown here can be used to calculate the pressure loss caused by reducers and expanders:

- Calculate the ratio of the diameters d/D .
- From the nomogram read off the pressure loss as a function of flow velocity (downstream from the reduction) and the d/D ratio.

-  The nomogram only applies to liquids with a viscosity similar to that of water.

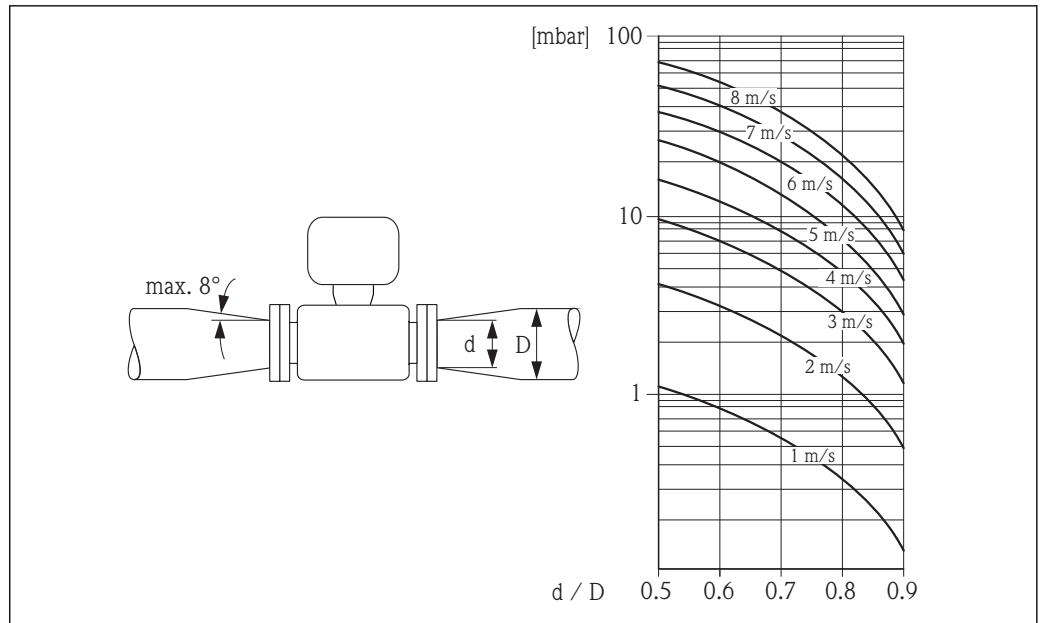

A0016359

Special mounting instructions

Display protection

To ensure that the optional display protection can be easily opened, maintain the following minimum head clearance: 350 mm (13.8 in)

Environment

Ambient temperature range

Transmitter	-40 to +60 °C (-40 to +140 °F)
Local display	-20 to +60 °C (-4 to +140 °F), the readability of the display may be impaired at temperatures outside the temperature range.
Sensor	-20 to +60 °C (-4 to +140 °F)
Liner	Do not exceed or fall below the permitted temperature range of the liner .

If operating outdoors:

- Install the measuring device in a shady location.
- Avoid direct sunlight, particularly in warm climatic regions.
- Avoid direct exposure to weather conditions.

i Weather protection covers can be ordered from Endress+Hauser: see "Accessories" section → 66

Temperature tables

The following interdependencies between the permitted ambient and fluid temperatures apply when operating the device in hazardous areas:

NOTICE

The ambient temperature changes for installations with overvoltage protection in conjunction with temperature classes T5 and T6.

The following applies for basic specification, position 1, 2 (approval) = BJ, B5, BH, IJ, I6, IH, C2, NF, N6, NH, NK, MJ:

- ▶ $T_a = T_a - 2 \text{ K}$

SI units

T _a [°C]	T6 [85 °C]	T5 [100 °C]	T4 [135 °C]	T3 [200 °C]	T2 [300 °C]	T1 [450 °C]
40	80	95	130	150	150	150
55	-	95	130	150	150	150
60 ¹⁾	-	95	130	150	150	150

1) The following applies for Basic specification, Position 3 (Output) = A, B, E, G: P_i = 0.85 W

US units

T _a [°F]	T6 [185 °F]	T5 [212 °F]	T4 [275 °F]	T3 [392 °F]	T2 [572 °F]	T1 [842 °F]
104	176	203	266	302	302	302
131	-	203	266	302	302	302
140 ¹⁾	-	203	266	302	302	302

1) The following applies for basic specification, position 3 (output) = A, B, E, G: P_i = 0.85 W

Storage temperature

The storage temperature corresponds to the operating temperature range of the measuring transmitter and the appropriate measuring sensors.

- Protect the measuring device against direct sunlight during storage in order to avoid unacceptably high surface temperatures.
- Select a storage location where moisture cannot collect in the measuring device as fungus or bacteria infestation can damage the liner.
- If protection caps or protective covers are mounted these should never be removed before installing the measuring device.

Degree of protection**Transmitter**

- As standard: IP66/67, type 4X enclosure
- When housing is open: IP20, type 1 enclosure
- Display module: IP20, type 1 enclosure

Sensor

IP66/67, type 4X enclosure

Connector

IP67, only in screwed situation

Shock resistance

As per IEC/EN 60068-2-31

Vibration resistance

Acceleration up to 2 g, according to IEC 60068-2-6

Mechanical load

- Protect the transmitter housing against mechanical effects, such as shock or impact.
- Never use the transmitter housing as a ladder or climbing aid.

Electromagnetic compatibility (EMC)

As per IEC/EN 61326 and NAMUR Recommendation 21 (NE 21)



For details, refer to the Declaration of Conformity.

Process**Medium temperature range**

-20 to +150 °C (-4 to +302 °F) for PFA

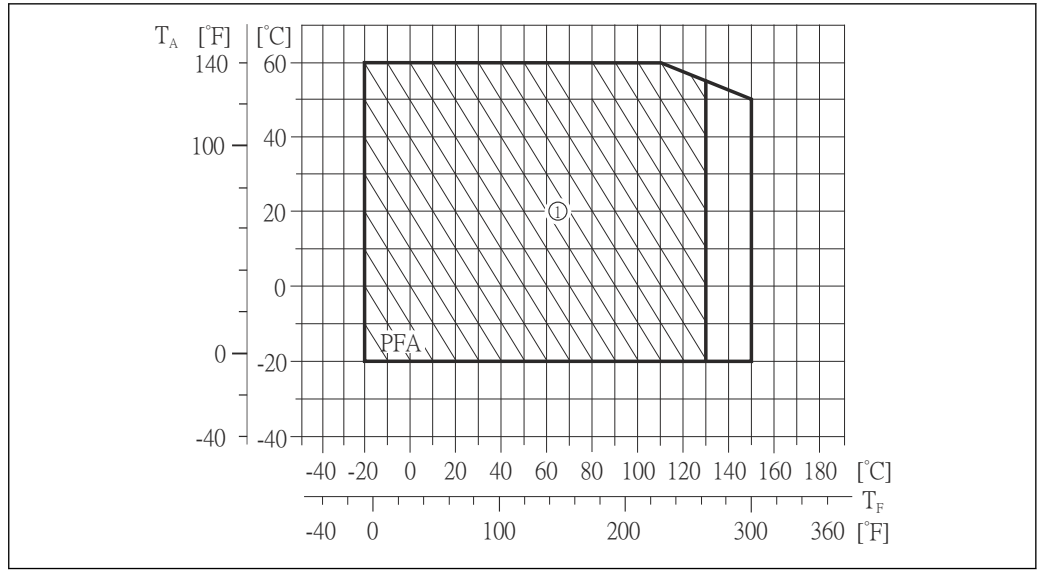

T_A Ambient temperature

T_F Medium temperature

1 Hatched area: harsh environment only up to +130 °C (+266 °F)

Conductivity ≥ 20 μS/cm for liquids in general

Pressure-temperature ratings

The following pressure-temperature ratings refer to the entire device and not just the process connection.

Process connections with O-ring seal, DN 2 to 25 (1/12 to 1")

Process connection: weld-in nipple according to DIN EN ISO 1127, ODT/SMS, ISO 2037; coupling according to ISO 228 / DIN 2999, NPT

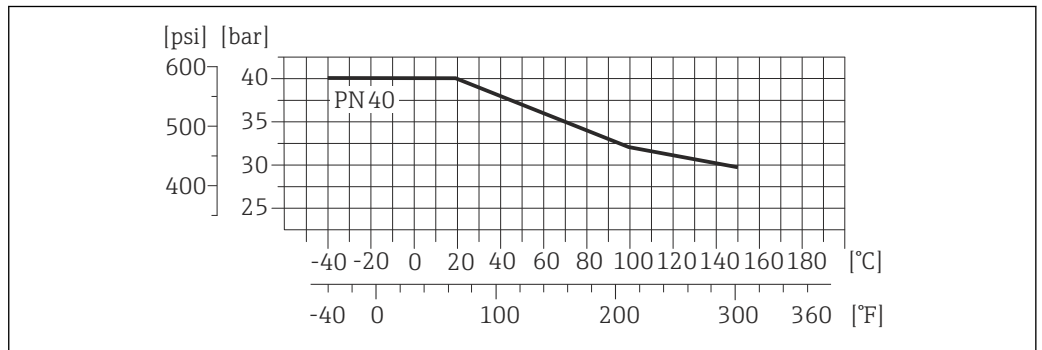

9 Process connection material: stainless steel, 1.4404 (F316L)

Process connection: flange according to EN 1092-1 (DIN 2501), adhesive sleeve

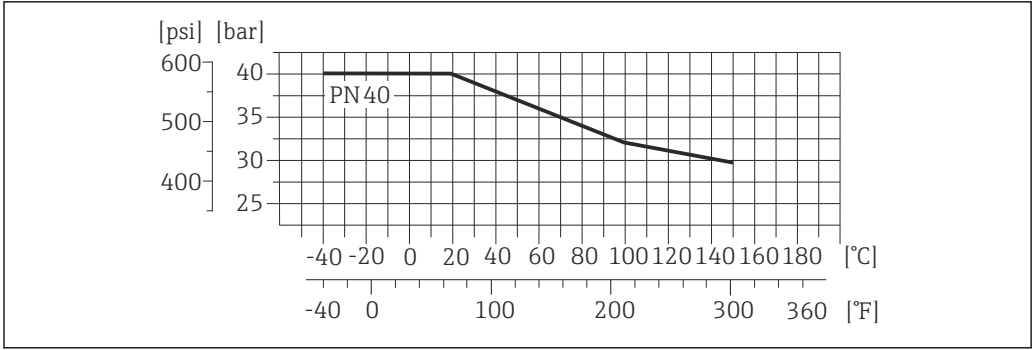

10 Process connection material: stainless steel, 1.4404 (F316L)

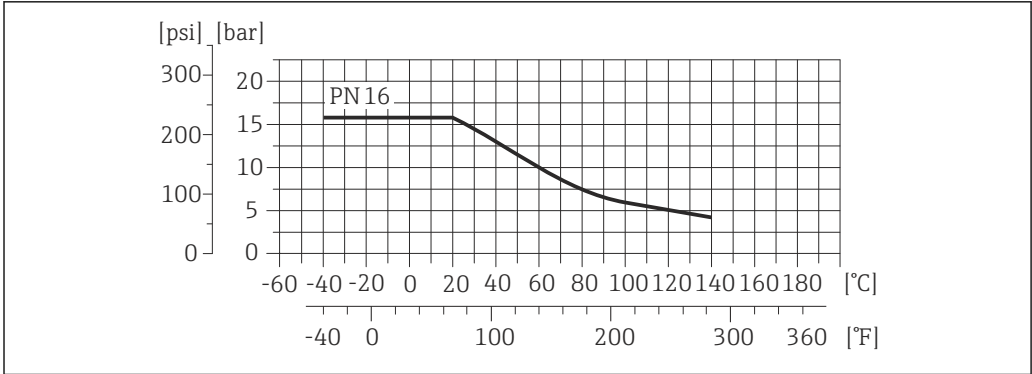

11 Process connection material: PVDF

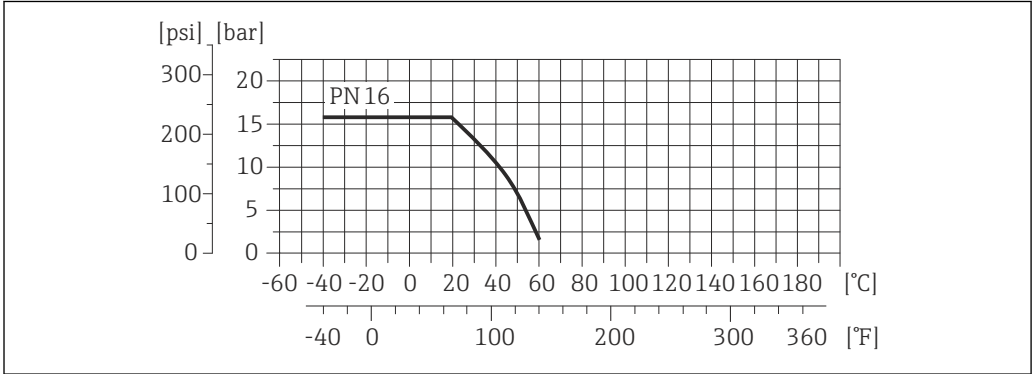

12 Process connection material: PVC-U

Process connection: flange according to ASME B16.5

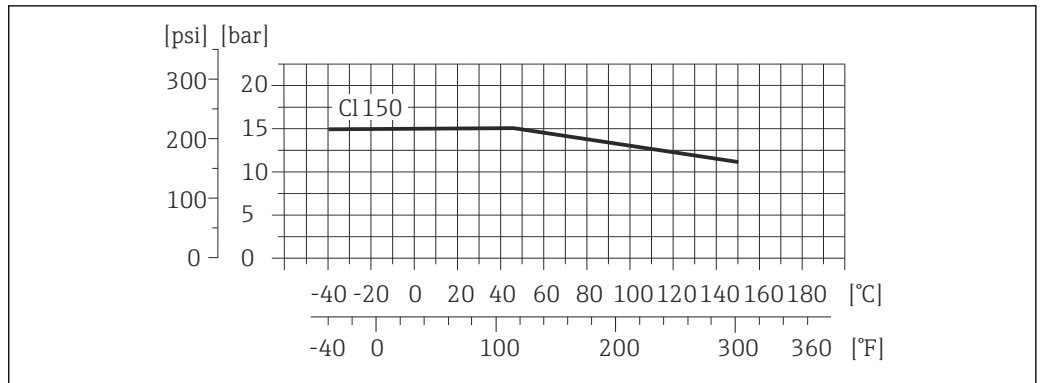

A0021192-EN

13 Process connection material: stainless steel, 1.4404 (F316L)

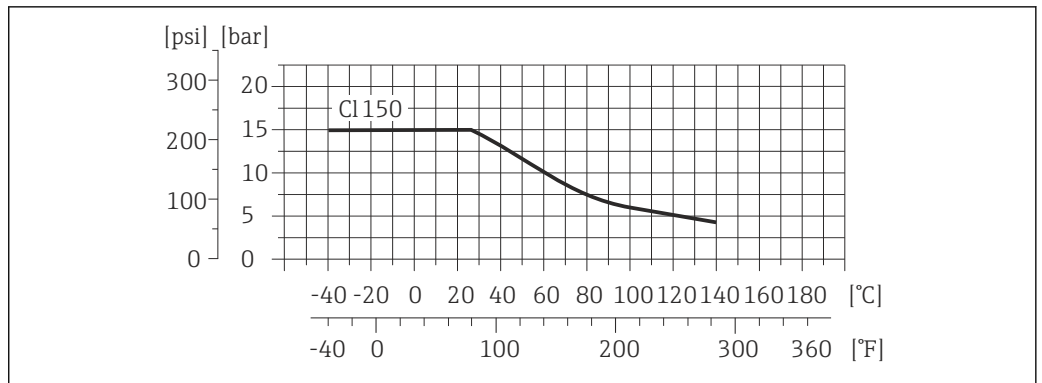

A0021192-EN

14 Process connection material: PVDF

Process connection: flange according to JIS B2220

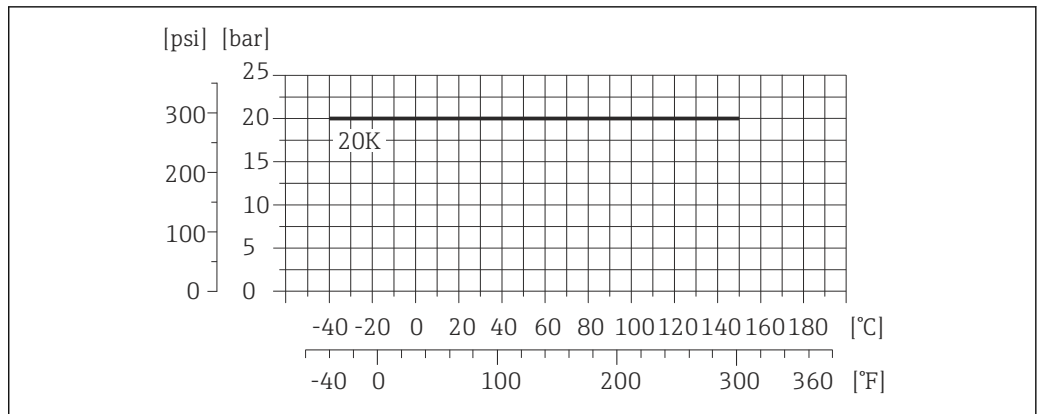

A0021193-EN

15 Process connection material: stainless steel, 1.4404 (F316L)

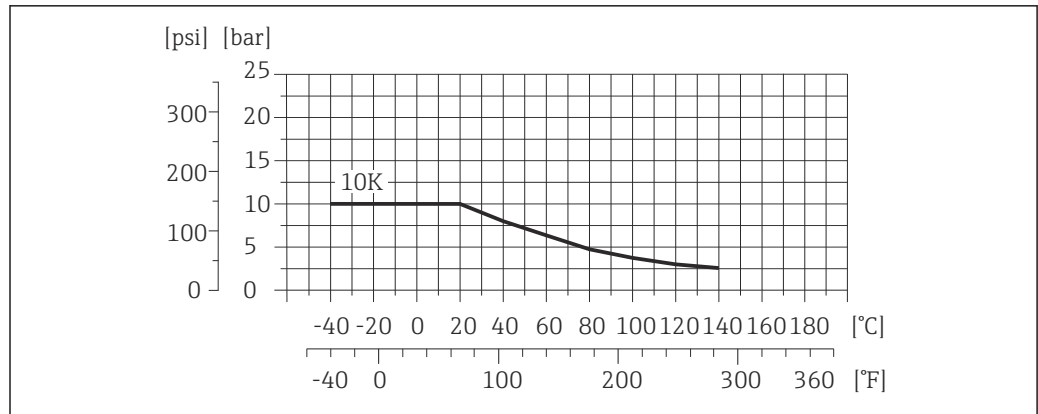

16 Process connection material: PVDF

Process connections with aseptic molded seal, DN 2 to 25 (1/12 to 1")

Process connection: weld-in nipple according to EN 10357 (DIN 11850), ASME BPE, ISO 2037; Clamp according to ISO 2852, DIN 32676, L14 AM7; coupling according to SC DIN 11851, DIN 11864-1, SMS 1145; flange according to DIN 11864-2

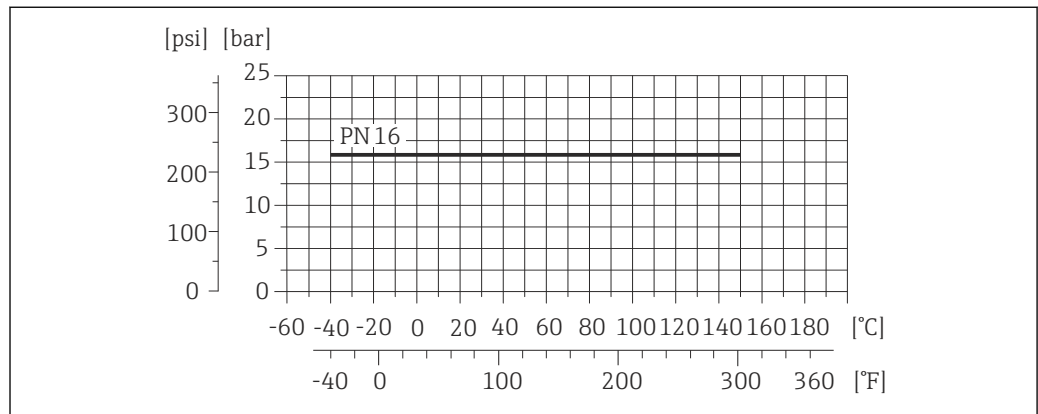

17 Process connection material: stainless steel, 1.4404 (F316L)

Pressure tightness

Liner: PFA

Nominal diameter		Limit values for absolute pressure in [mbar] ([psi]) for fluid temperatures:				
[mm]	[in]	+25 °C (+77 °F)	+80 °C (+176 °F)	+100 °C (+212 °F)	+130 °C (+266 °F)	+150 °C (+302 °F)
2 to 25	1/12 to 1	0 (0)	0 (0)	0 (0)	0 (0)	0 (0)

Flow limit

The diameter of the pipe and the flow rate determine the nominal diameter of the sensor. The optimum velocity of flow is between 2 to 3 m/s (6.56 to 9.84 ft/s). Also match the velocity of flow (v) to the physical properties of the fluid:

- v < 2 m/s (6.56 ft/s): for abrasive fluids
- v > 2 m/s (6.56 ft/s): for fluids producing buildup

i A necessary increase in the flow velocity can be achieved by reducing the sensor nominal diameter.

i For an overview of the measuring range full scale values, see the "Measuring range" section → 5

Pressure loss

- No pressure loss occurs as of nominal diameter DN 8 (3/8") if the sensor is installed in a pipe with the same nominal diameter.
- Pressure losses for configurations incorporating adapters according to DIN EN 545 → 28

System pressure

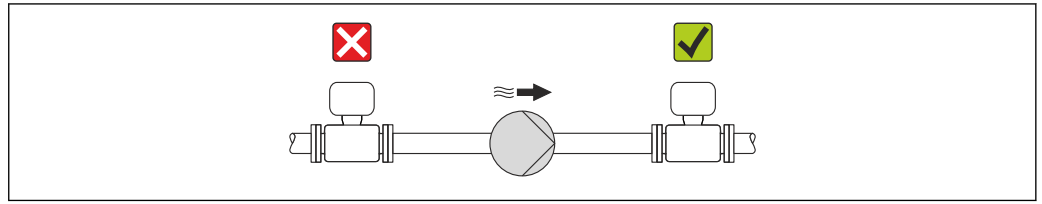

A0015594

Never install the sensor on the pump suction side in order to avoid the risk of low pressure, and thus damage to the liner.

i Furthermore, install pulse dampers if reciprocating, diaphragm or peristaltic pumps are used.

- i** ■ For information on the liner's resistance to partial vacuum → 34
- i** ■ For information on the shock resistance of the measuring system → 30
- For information on the vibration resistance of the measuring system → 30

Vibrations

In the event of very strong vibrations, the pipe and sensor must be supported and fixed.

- i** ■ For information on the shock resistance of the measuring system → 30
- For information on the vibration resistance of the measuring system → 30

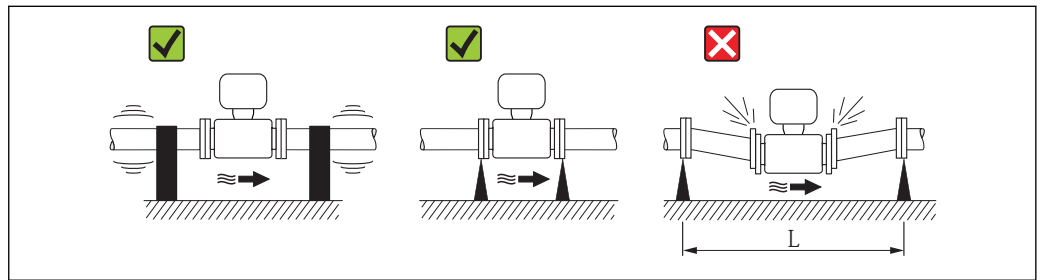

A0016266

18 Measures to avoid device vibrations ($L > 10\text{ m}$ (33 ft))

Mechanical construction

Dimensions in SI units

Compact version

Order code for "Housing", option C "GT20 two-chamber, aluminum coated"

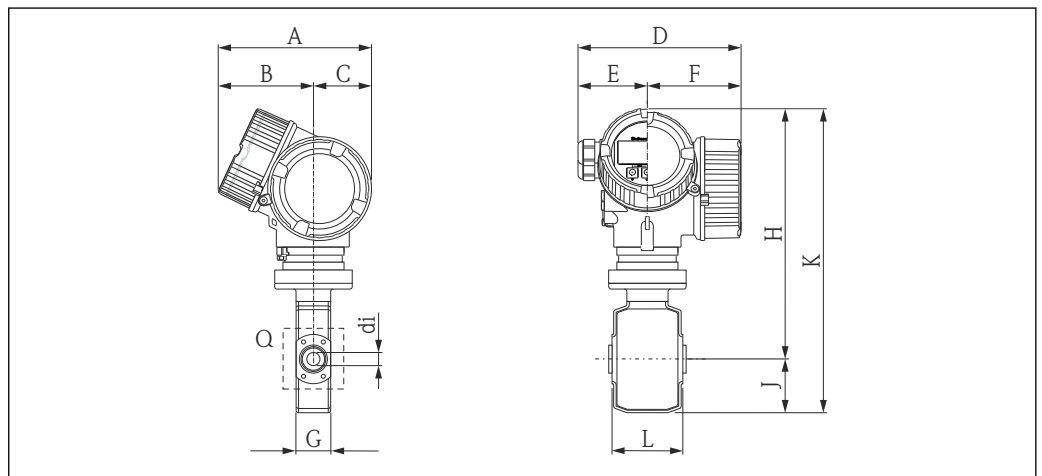

A0017653

DN	A	B ¹⁾	C	D ²⁾	E	F ²⁾	G	H ³⁾	J	K ³⁾	L ⁴⁾	Q	di
[mm]	[mm]	[mm]	[mm]	[mm]	[mm]	[mm]	[mm]	[mm]	[mm]	[mm]	[mm]	[mm]	[mm]
2	162	102	60	165	75	90	43	272	55	327	86	4 × M6	2.25
4	162	102	60	165	75	90	43	272	55	327	86	4 × M6	4.5
8	162	102	60	165	75	90	43	272	55	327	86	4 × M6	9
15	162	102	60	165	75	90	43	272	55	327	86	4 × M6	16
25	162	102	60	165	75	90	56	272	55	327	86	4 × M6	26

- 1) For version without local display: values - 7 mm
- 2) For version with overvoltage protection (OVP): values + 8 mm
- 3) For version without local display: values - 10 mm
- 4) Total length (L) depends on the process connections.

Detail Q, sensor flange connection

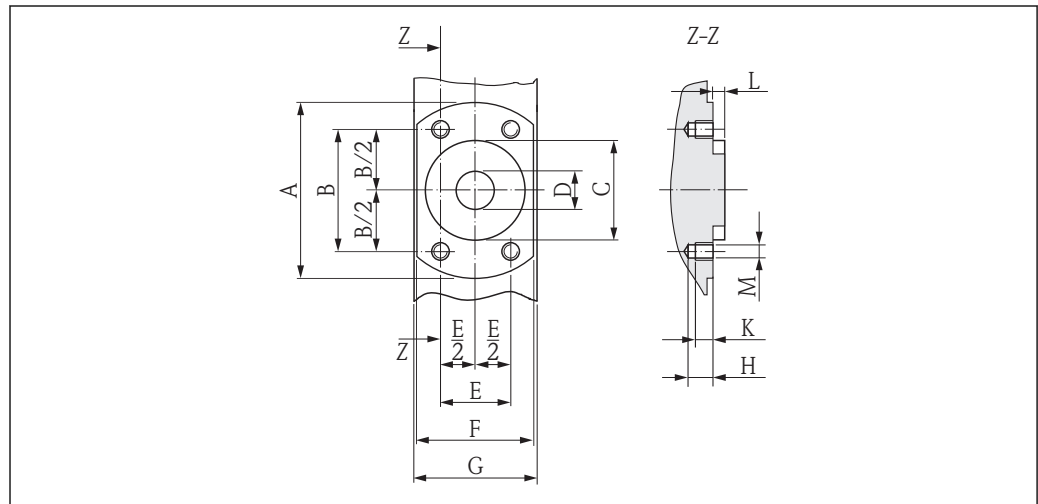

19 Front view without process connections

DN	A	B	C	D	E	F	G	H	K	L	M
[mm]	[mm]	[mm]	[mm]	[mm]	[mm]	[mm]	[mm]	[mm]	[mm]	[mm]	[mm]
2	62	41.6	34	9	24	42	43	8.5	6	4	M6
4	62	41.6	34	9	24	42	43	8.5	6	4	M6
8	62	41.6	34	9	24	42	43	8.5	6	4	M6
15	62	41.6	34	16	24	42	43	8.5	6	4	M6
25	72	50.2	44	26	29	55	56	8.5	6	4	M6

Flanges

Fixed flange with O-ring seal

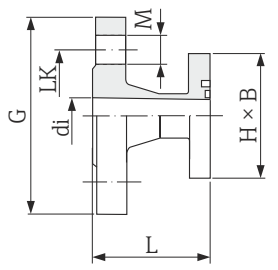
Fixed flange according to EN 1092-1 (DIN 2501), Form B: PN 40 1.4404 (316L) Order code for "Process connection", option D5S								
	DN	Suitable for flange EN 1092-1 (DIN 2501)	di	G	L	LK	M	H × B
	[mm]	[mm]	[mm]	[mm]	[mm]	[mm]	[mm]	[mm]
 <p>A0005549</p>	2 to 8	DN 15	17.3	95	56.2	65	14	62 × 42
	15	DN 15	17.3	95	56.2	65	14	62 × 42
	25 (DIN)	DN 25	28.5	115	56.2	85	14	72 × 55
	Length = (2 × L) + 86 mm Length in accordance with DVGW (200 mm)							

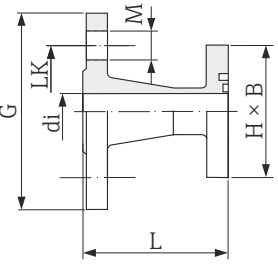
Fixed flange according to ASME B16.5: Class 150 1.4404 (316L) Order code for "Process connection", option A1S								
	DN	Suitable for flange ASME B16.5	di	G	L	LK	M	H × B
	[mm]	[in]	[mm]	[mm]	[mm]	[mm]	[mm]	[mm]
 <p>A0005550</p>	2 to 8	½	15.7	89	66	60.5	15.7	62 × 42
	15	½	16	89	66	60.5	15.7	62 × 42
	25 (1" ASME)	1	26.7	108	71.8	79.2	15.7	72 × 55
	Length = (2 × L) + 86 mm							

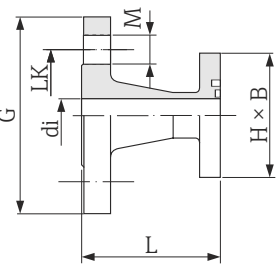
Fixed flange according to JIS B2220: 20K 1.4404 (316L) Order code for "Process connection", option N4S								
	DN	Suitable for flange JIS B2220	di	G	L	LK	M	H × B
	[mm]	[mm]	[mm]	[mm]	[mm]	[mm]	[mm]	[mm]
 <p>A0005551</p>	2 to 8	DN 15	15	95	67	70	15	62 × 42
	15	DN 15	16	95	67	70	15	62 × 42
	25 (DIN)	DN 25	26	125	67	90	19	72 × 55
	Length = (2 × L) + 86 mm							

Lap joint flange with O-ring seal

Lap joint flange according to EN 1092-1 (DIN 2501): PN 16 PVDF Order code for "Process connection", option D3P								
	DN	Suitable for flange EN 1092-1 (DIN 2501)	di	G	L	LK	M	H × B
	[mm]	[mm]	[mm]	[mm]	[mm]	[mm]	[mm]	[mm]
<p>A0005567</p>	2 to 8	DN 15	16	95	57	65	14	62 × 42
	15	DN 15	16	95	57	65	14	62 × 42
	25 (DIN)	DN 25	27.2	115	57	85	14	72 × 55
Length = (2 × L) + 86 mm Length in accordance with DVGW (200 mm) The required grounding rings can be ordered as accessories (order code: DK5HR-****).								

Lap joint flange with grounding electrode according to EN 1092-1 (DIN 2501): PN 16 PVDF Order code for "Process connection", option D4P								
	DN	Suitable for flange EN 1092-1 (DIN 2501)	di	G	L	LK	M	H × B
	[mm]	[mm]	[mm]	[mm]	[mm]	[mm]	[mm]	[mm]
<p>A0017292</p>	2 to 8	DN 15	16	95	57	65	14	62 × 42
	15	DN 15	16	95	57	65	14	62 × 42
	25 (DIN)	DN 25	27.2	115	57	85	14	72 × 55
Length = (2 × L) + 86 mm Length in accordance with DVGW (200 mm) Grounding rings are not necessary.								

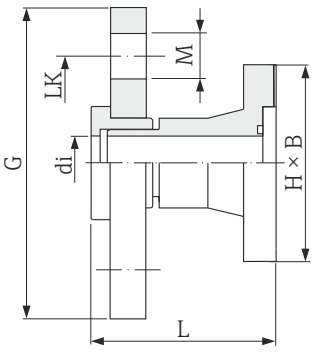
Lap joint flange according to ASME B16.5: Class 150 PVDF Order code for "Process connection", option A1P								
	DN	Suitable for flange ASME B16.5	di	G	L	LK	M	H × B
	[mm]	[in]	[mm]	[mm]	[mm]	[mm]	[mm]	[mm]
	2 to 8	½	16	95	57	60	16	62 × 42
	15	½	16	95	57	60	16	62 × 42
	25 (DIN)	1	27.2	115	57	79	16	72 × 55
Length = (2 × L) + 86 mm The required grounding rings can be ordered as accessories (order code: DK5HR-****).								

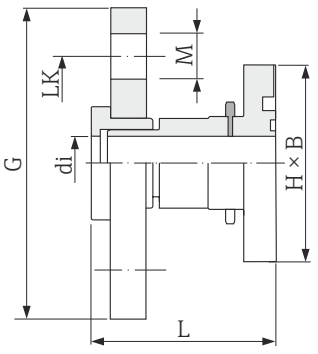
Lap joint flange with grounding electrode according to ASME B16.5: Class 150 PVDF Order code for "Process connection", option A4P								
	DN	Suitable for flange ASME B16.5	di	G	L	LK	M	H × B
	[mm]	[in]	[mm]	[mm]	[mm]	[mm]	[mm]	[mm]
	2 to 8	½	16	95	57	60	16	62 × 42
	15	½	16	95	57	60	16	62 × 42
	25 (DIN)	1	27.2	115	57	79	16	72 × 55
Length = (2 × L) + 86 mm Grounding rings are not necessary.								

Lap joint flange according to JIS B2220: 10K
PVDF

Order code for "Process connection", option N3P

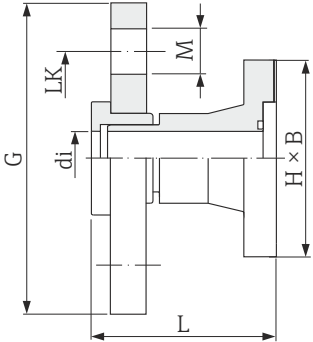
	DN	Suitable for flange JIS B2220	di	G	L	LK	M	H × B
	[mm]	[mm]	[mm]	[mm]	[mm]	[mm]	[mm]	[mm]
	2 to 8	DN 15	16	95	57	70	15	62 × 42
	15	DN 15	16	95	57	70	15	62 × 42
	25 (DIN)	DN 25	27.2	125	57	90	19	72 × 55
Length = $(2 \times L) + 86$ mm The required grounding rings can be ordered as accessories (order code: DK5HR-****).								

Lap joint flange with grounding electrode according to JIS B2220: 10K
PVDF

Order code for "Process connection", option N4P

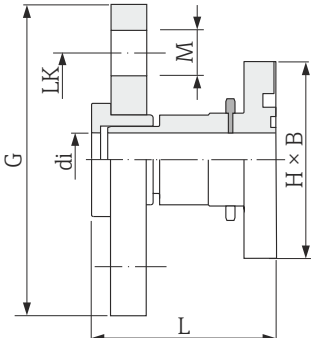
	DN	Suitable for flange JIS B2220	di	G	L	LK	M	H × B
	[mm]	[mm]	[mm]	[mm]	[mm]	[mm]	[mm]	[mm]
	2 to 8	DN 15	16	95	57	70	15	62 × 42
	15	DN 15	16	95	57	70	15	62 × 42
	25 (DIN)	DN 25	27.2	125	57	90	19	72 × 55
Length = $(2 \times L) + 86$ mm Grounding rings are not necessary.								

Grooved flange with O-ring seal
Flange DIN 11864-2, aseptic grooved flange, Form A
1.4404 (316L)

Order code for "Process connection", option DES

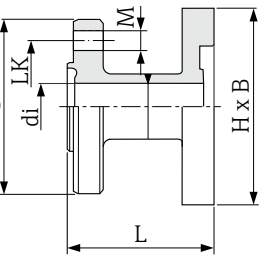
	DN	Suitable for pipe EN 10357 (DIN 11850)	di	G	L	LK	M	H × B
	[mm]	[mm]	[mm]	[mm]	[mm]	[mm]	[mm]	[mm]
	2 to 8	Pipe 13 × 1.5 (DN 10)	10	54	48.5	37	9	62 × 42
	15	Pipe 19 × 1.5 (DN 15)	16	59	48.5	42	9	62 × 42
	25 (DIN)	Pipe 29 × 1.5 (DN 25)	26	70	48.5	53	9	72 × 55
Length = $(2 \times L) + 86$ mm Please note the internal diameters of the measuring tube and process connection (di) when cleaning with pigs.								

Clamp connections

With aseptic molded seal

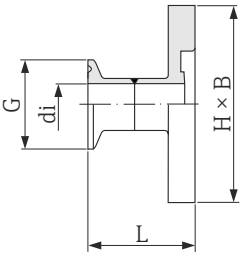
Clamp according to DIN 32676 1.4404 (316L) Order code for "Process connection", option DBS						
	DN [mm]	Suitable for pipe EN 10357 (DIN 11850) [mm]	di [mm]	G [mm]	L [mm]	H × B [mm]
 <p>A000556</p>	2 to 8	Pipe 14 × 2 (DN 10)	10	34	41	62 × 42
	15	Pipe 20 × 2 (DN 15)	16	34	41	62 × 42
	25 (DIN)	Pipe 30 × 2 (DN 25)	26	50.5	44.5	72 × 55
Length = (2 × L) + 86 mm Please note the internal diameters of the measuring tube and process connection (di) when cleaning with pigs.						

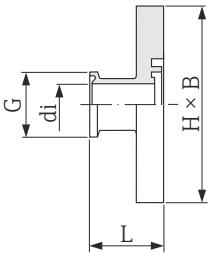
Tri-Clamp for L14 AM7 1.4404 (316L) Order code for "Process connection", option FAS						
	DN [mm]	Suitable for pipe ODT [mm] ([in])	di [mm]	G [mm]	L [mm]	H × B [mm]
 <p>A0003872</p>	2 to 8	Pipe 12.7 × 1.65 (ODT ½")	9.4	25	28.5	62 × 42
	15	Pipe 19.1 × 1.65 (ODT ¾")	15.8	25	28.5	62 × 42
	25 (1" ASME)	Pipe 25.4 × 1.65 (ODT 1")	22.1	50.4	28.5	72 × 55
Length = (2 × L) + 86 mm Please note the internal diameters of the measuring tube and process connection (di) when cleaning with pigs.						

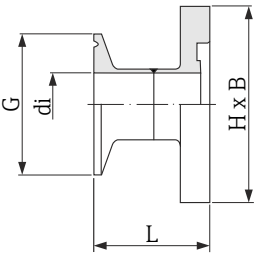
Clamp according to ISO 2852, Fig. 2 1.4404 (316L) Order code for "Process connection", option IBS							
	DN [mm]	Suitable for pipe ISO 2037/BS 4825-1 [mm]	DN Clamp ISO 2852 [mm]	di [mm]	G [mm]	L [mm]	H × B [mm]
 <p>A0005560</p>	2...8 (½")	24.5 × 1.65	25	22.6	50.5	44.3	72 × 55
	15 (¾")	24.5 × 1.65	25	22.6	50.5	44.3	72 × 55
	25 (1")	24.5 × 1.65	25	22.6	50.5	44.3	72 × 55
Length = (2 × L) + 86 mm Please note the internal diameters of the measuring tube and process connection (di) when cleaning with pigs.							

Cable glands

Threaded adapter with O-ring seal

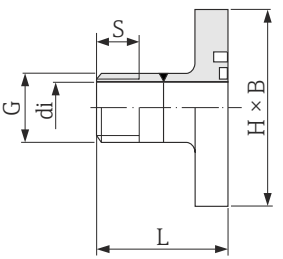
External thread according to ISO 228/DIN 2999 1.4404 (316L) Order code for "Process connection", option I2S							
	DN	Suitable for internal thread ISO 228 / DIN 2999	di	G	L	S	H × B
	[mm]	[in]	[mm]	[in]	[mm]	[mm]	[mm]
 <p>A0005563</p>	2 to 8	R 3/8	10	3/8	40	10.1	62 × 42
	15	R 1/2	16	1/2	40	13.2	62 × 42
	25 (1" ASME)	R 1	25	1	42	16.5	72 × 55
Length = (2 × L) + 86 mm							

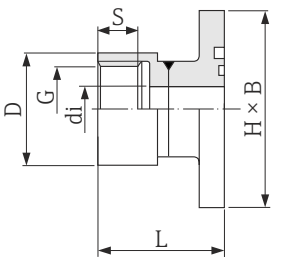
Internal thread according to ISO 228/DIN 2999 1.4404 (316L) Order code for "Process connection", option I3S								
	DN	Suitable for external thread ISO 228 / DIN 2999	di	G	D	L	S	H × B
	[mm]	[in]	[mm]	[in]	[mm]	[mm]	[mm]	[mm]
 <p>A0005565</p>	2 to 8	Rp 3/8	9	3/8	22	45	13	62 × 42
	15	Rp 1/2	16	1/2	27	45	14	62 × 42
	25 (1" ASME)	Rp 1	27.2	1	40	51	17	72 × 55
Length = (2 × L) + 86 mm								

Threaded adapter with aseptic molded seal

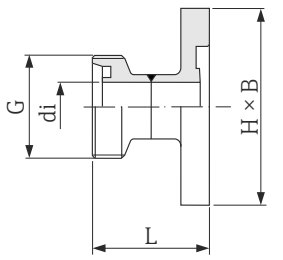
Coupling SC DIN 11851, threaded adapter 1.4404 (316L) Order code for "Process connection", option DCS						
	DN	Suitable for pipe EN 10357 (DIN 11850)	di	G	L	H × B
	[mm]	[mm]	[mm]	[mm]	[mm]	[mm]
 <p>A0005553</p>	2 to 8	Pipe 12 × 1 (DN 10)	10	Rd 28 × 1/8	44	62 × 42
	15	Pipe 18 × 1.5 (ODT 3/4")	16	Rd 34 × 1/8	44	62 × 42
	25 (DIN)	Pipe 28 × 1 or 28×1.5 (DN 25)	26	Rd 52 × 1/6	52	72 × 55
Length = (2 × L) + 86 mm Please note the internal diameters of the measuring tube and process connection (di) when cleaning with pigs.						

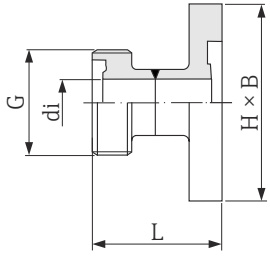
Coupling DIN 11864-1, aseptic threaded hygienic connection, Form A 1.4404 (316L) Order code for "Process connection", option DDS						
	DN [mm]	Suitable for pipe EN 10357 (DIN 11850) [mm]	di [mm]	G [mm]	L [mm]	H × B [mm]
 <p>A0005558</p>	2 to 8	Pipe 13 × 1.5 (DN 10)	10	Rd 28 × 1/8	42	62 × 42
	15	Pipe 19 × 1.5 (DN 15)	16	Rd 34 × 1/8	42	62 × 42
	25 (DIN)	Pipe 29 × 1.5 (DN 25)	26	Rd 52 × 1/8	49	72 × 55
Length = (2 × L) + 86 mm Please note the internal diameters of the measuring tube and process connection (di) when cleaning with pigs.						

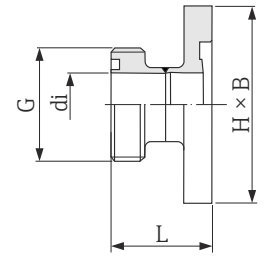
Coupling SMS 1145, threaded adapter 1.4404 (316L) Order code for "Process connection", option SAS							
	DN [mm]	Suitable for pipe OD [mm]	DN SMS 1145 [mm]	di [mm]	G [mm]	L [mm]	H × B [mm]
 <p>A0005564</p>	25 (1" ASME)	1	25	22.6	Rd 40 × 1/8	30.8	72 × 55
	Length = (2 × L) + 86 mm Please note the internal diameters of the measuring tube and process connection (di) when cleaning with pigs.						

Weld-in nipple

With O-ring seal

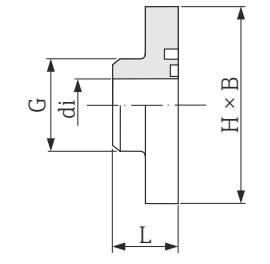
Weld-in nipple according to ODT/SMS 1.4404 (316L) Order code for "Process connection", option A2S						
	DN [mm]	Suitable for pipe ODT/SMS [mm]	di [mm]	G [mm]	L [mm]	H × B [mm]
 <p>A0005548</p>	2 to 8	13.5 × 2.30	9	13.5	20.3	62 × 42
	15	21.3 × 2.65	16	21.3	20.3	62 × 42
	25 (DIN)	33.7 × 3.25	27.2	33.7	20.3	72 × 55
Length = (2 × L) + 86 mm						

**Weld-in nipple according to DIN EN ISO 1127
1.4404 (316L)**
Order code for "Process connection", option D1S

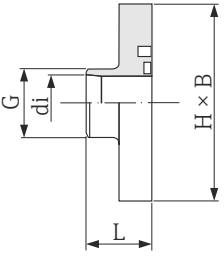
	DN	Suitable for pipe DIN EN ISO 1127	di	G	L	H × B
	[mm]	[mm]	[mm]	[mm]	[mm]	[mm]
	2 to 8	13.5 × 1.6	10.3	13.5	20.3	62 × 42
	15	21.3 × 1.6	18.1	21.3	20.3	62 × 42
	25 (DIN)	33.7 × 2.0	29.7	33.7	20.3	62 × 52
Length = (2 × L) + 86 mm						

A0005547

**Weld-in nipple according to ISO 2037
1.4404 (316L)**
Order code for "Process connection", option I1S

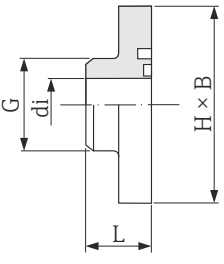
	DN	Suitable for pipe ISO 2037	di	G	L	H × B
	[mm]	[mm]	[mm]	[mm]	[mm]	[mm]
	2 to 8	13.5 × 2.3	9	13.5	20.3	62 × 42
	15	21.3 × 2.65	16	21.3	20.3	62 × 42
	25 (DIN)	33.7 × 3.25	27.2	33.7	20.3	72 × 55
Length = (2 × L) + 86 mm						

A0005548

With aseptic molded seal
**Weld-in nipple according to EN 10357 (DIN 11850)
1.4404 (316L)**
Order code for "Process connection", option DAS

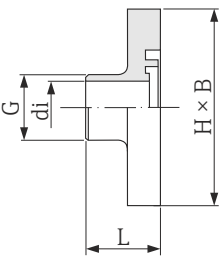
	DN	Suitable for pipe EN 10357 (DIN 11850)	di	G	L	H × B
	[mm]	[mm]	[mm]	[mm]	[mm]	[mm]
	2 to 8	13 × 1.5	10	13	23.3	62 × 42
	15	19 × 1.5	16	19	23.3	62 × 42
	25 (DIN)	29 × 1.5	26	29	23.3	72 × 55
Length = (2 × L) + 86 mm						
Please note the internal diameters of the measuring tube and process connection (di) when cleaning with pigs.						

A0003870

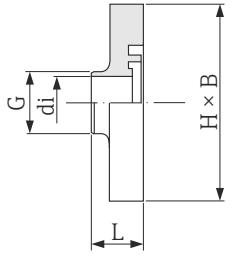
Weld-in nipple according to ISO 2037 1.4404 (316L) Order code for "Process connection", option IAS						
	DN	Suitable for pipe ISO 2037	di	G	L	H × B
	[mm]	[mm]	[mm]	[mm]	[mm]	[mm]
	2 to 8	12.7 × 1.65	9	12.7	16.1	62 × 42
	15	19.1 × 1.65	16	19.1	16.1	62 × 42
	25 (1" ASME)	25.4 × 1.65	22.6	25.4	16.1	72 × 55
Length = (2 × L) + 86 mm Please note the internal diameters of the measuring tube and process connection (di) when cleaning with pigs.						

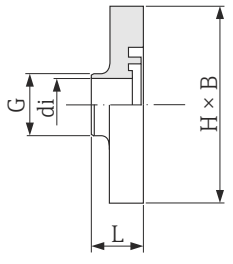
Weld-in nipple according to ASME BPE 1.4404 (316L) Order code for "Process connection", option AAS						
	DN	Suitable for pipe ASME BPE	di	G	L	H × B
	[mm]	[mm]	[mm]	[mm]	[mm]	[mm]
	2 to 8	12.7 × 1.65	9	12.7	16.1	62 × 42
	15	19.1 × 1.65	16	19.1	16.1	62 × 42
	25 (1" ASME)	25.4 × 1.65	22.6	25.4	16.1	72 × 55
Length = (2 × L) + 86 mm Please note the internal diameters of the measuring tube and process connection (di) when cleaning with pigs.						

Hose adapter

With O-ring seal

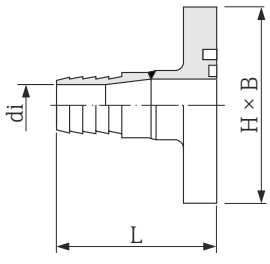
Hose adapter 1.4404 (316L) Order code for "Process connection", options O1S, O2S, O3S					
	DN	Suitable for internal diameter	di	L	H × B
	[mm]	[mm]	[mm]	[mm]	[mm]
	2 to 8	13	10	49	62 × 42
	15	16	12.6	49	62 × 42
	15	19	16	49	72 × 55
Length = (2 × L) + 86 mm					

Adhesive sleeves

With O-ring seal

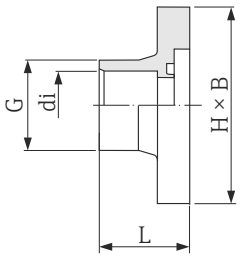
Adhesive sleeve PVC Order code for "Process connection", options O1V, O2V						
	DN [mm]	Suitable for pipe [mm] / [in]	di [mm]	G [mm]	L [mm]	H × B [mm]
 <p>A0005566</p>	2 to 8	20 × 2 (DIN 8062)	20.2	27	38.5	62 × 42
	2 to 8	½	21.5	27.3	38.5	62 × 42
	15	20 × 2 (DIN 8062)	20.2	27	28	72 × 55
Length = (2 × L) + 86 mm The required grounding rings can be ordered as accessories (order code: DK5HR-****).						

Mountings sets

Wall mounting kit

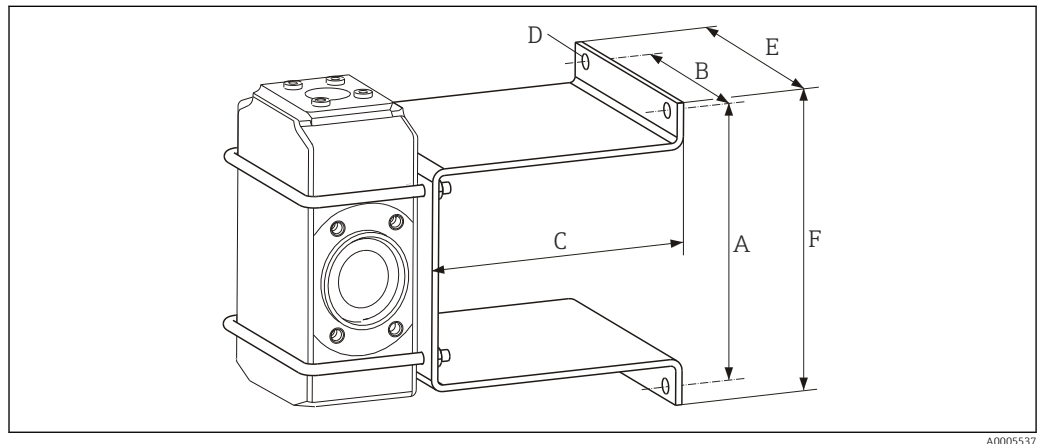

A [mm]	B [mm]	C [mm]	Ø D [mm]	E [mm]	F [mm]
125	88	120	7	110	140

Accessories

Threaded adapters with O-ring seal available for order

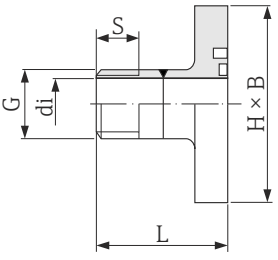
External thread 1.4404 (316L) Order code: DKH**-GD**							
	DN	Suitable for internal thread NP	di	G	L	S	H × B
	[mm]	[in]	[mm]	[in]	[mm]	[mm]	[mm]
 <p>A0005563</p>	2 to 8	NPT 3/8	10	3/8	50	15.5	62 × 42
	15	NPT ½	16	½	50	20	62 × 42
	25 (1" ASME)	NPT 1	25	1	55	25	72 × 55
Length = (2 × L) + 86 mm							

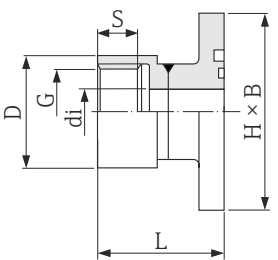
Internal thread 1.4404 (316L) Order code: DKH**-GC**								
	DN	Suitable for external thread NP	di	G	D	L	S	H × B
	[mm]	[in]	[mm]	[in]	[mm]	[mm]	[mm]	[mm]
 <p>A0005565</p>	2 to 8	NPT 3/8	8.9	3/8	22	45	13	62 × 42
	15	NPT ½	16	½	27	45	14	62 × 42
	25 (1" ASME)	NPT 1	27.2	1	40	51	17	72 × 55
Length = (2 × L) + 86 mm								

Clamp connections with aseptic molded seal available for order

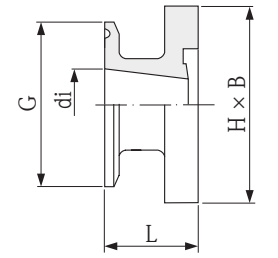
Tri-Clamp for L14 AM17 1.4404 (316L) Order code: DKH**-HF**						
	DN	Suitable for pipe OD	di	G	L	H × B
	[mm]	[mm] ([in])	[mm]	[mm]	[mm]	[mm]
 <p>A0005555</p>	15	Pipe ODT 1	22.1	50.4	28.5	62 × 42
	Length = (2 × L) + 86 mm Please note the internal diameters of the measuring tube and process connection (di) when cleaning with pigs.					

Grounding rings

For lap joint flange made of PVDF and PVC adhesive sleeve
 1.4435 (316L), Alloy C22, tantalum
 Order code: DK5HR-****

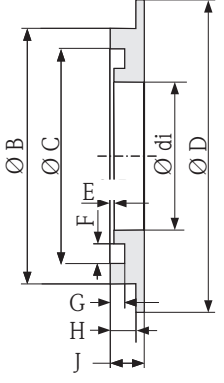
	DN	di	B	C	D	E	F	G	H	J
	[mm]	[mm]	[mm]	[mm]	[mm]	[mm]	[mm]	[mm]	[mm]	[mm]
	2 to 8	9	22	17.6	33.9	0.5	3.5	1.9	3.4	4.5
	15	16	29	24.6	33.9	0.5	3.5	1.9	3.4	4.5
	25 (DIN)	26	39	34.6	43.9	0.5	3.5	1.9	3.4	4.5

Dimensions in US units

Compact version

Order code for "Housing", option C "GT20 two-chamber, aluminum coated"

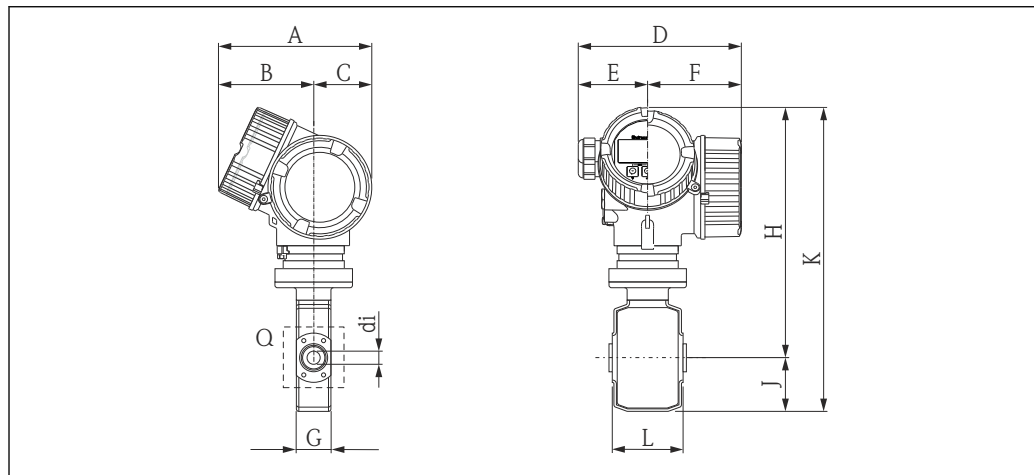

DN	A	B ¹⁾	C	D ²⁾	E	F ²⁾	G	H ³⁾	J	K ³⁾	L ⁴⁾	Q	di
[in]	[in]	[in]	[in]	[in]	[in]	[in]	[in]	[in]	[in]	[in]	[in]	[mm]	[in]
1/12	6.38	4.02	2.36	6.50	2.95	3.54	1.69	10.7	2.17	12.9	3.39	4 × M6	0.09
1/8	6.38	4.02	2.36	6.50	2.95	3.54	1.69	10.7	2.17	12.9	3.39	4 × M6	0.18
3/8	6.38	4.02	2.36	6.50	2.95	3.54	1.69	10.7	2.17	12.9	3.39	4 × M6	0.35

DN	A	B ¹⁾	C	D ²⁾	E	F ²⁾	G	H ³⁾	J	K ³⁾	L ⁴⁾	Q	di
[in]	[in]	[in]	[in]	[in]	[in]	[in]	[in]	[in]	[in]	[in]	[in]	[mm]	[in]
½	6.38	4.02	2.36	6.50	2.95	3.54	1.69	10.7	2.17	12.9	3.39	4 × M6	0.63
1	6.38	4.02	2.36	6.50	2.95	3.54	2.20	10.7	2.17	12.9	3.39	4 × M6	1.02

- 1) For version without local display: values - 0.28 in
- 2) For version with overvoltage protection (OVP): values + 0.31 in
- 3) For version without local display: values - 0.39 in
- 4) Total length (L) depends on the process connections.

Detail Q, sensor flange connection

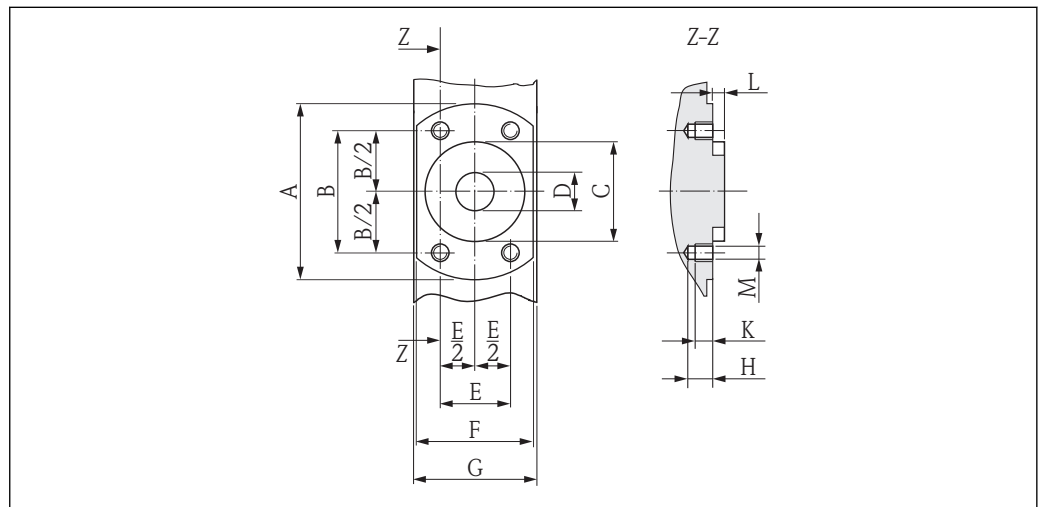

A0017657

20 Front view without process connections

DN	A	B	C	D	E	F	G	H	K	L	M
[in]	[in]	[in]	[in]	[in]	[in]	[in]	[in]	[in]	[in]	[in]	[mm]
1/12	2.44	1.64	1.34	0.35	0.94	1.65	1.69	0.33	0.24	0.16	M6
1/8	2.44	1.64	1.34	0.35	0.94	1.65	1.69	0.33	0.24	0.16	M6
3/8	2.44	1.64	1.34	0.35	0.94	1.65	1.69	0.33	0.24	0.16	M6
½	2.44	1.64	1.34	0.63	0.94	1.65	1.69	0.33	0.24	0.16	M6
1	2.83	1.98	1.73	0.89	1.14	2.17	2.20	0.33	0.24	0.16	M6

Flanges

Fixed flange with O-ring seal

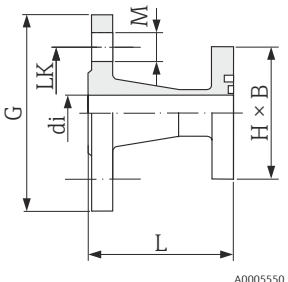
Fixed flange according to ASME B16.5: Class 150 1.4404 (316L) Order code for "Process connection", option A1S								
	DN	Suitable for flange ASME B16.5	di	G	L	LK	M	H × B
	[in]	[in]	[in]	[in]	[in]	[in]	[in]	[in]
 <p>A0005550</p>	1/12 to 3/8	1/2	0.62	3.50	2.60	2.38	0.62	2.44 × 1.65
	1/2	1/2	0.63	3.50	2.60	2.38	0.62	2.44 × 1.65
	1	1	1.05	4.25	2.83	3.12	0.62	2.83 × 2.17
Length = (2 × L) + 3.39 in								

Lap joint flange with O-ring seal

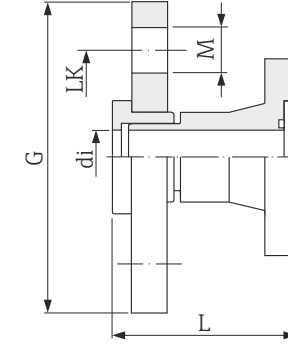
Lap joint flange according to ASME B16.5: Class 150 PVDF Order code for "Process connection", option A1P								
	DN	Suitable for flange ASME B16.5	di	G	L	LK	M	H × B
	[in]	[in]	[in]	[in]	[in]	[in]	[in]	[in]
 <p>A0005567</p>	1/12 to 3/8	1/2	0.63	3.74	2.24	2.36	0.63	2.44 × 1.65
	1/2	1/2	0.63	3.74	2.24	2.36	0.63	2.44 × 1.65
	Length = (2 × L) + 3.39 in The required grounding rings can be ordered as accessories (order code: DK5HR-****).							

Lap joint flange with grounding electrode according to ASME B16.5: Class 150 PVDF Order code for "Process connection", option A4P								
	DN	Suitable for flange ASME B16.5	di	G	L	LK	M	H × B
	[in]	[in]	[in]	[in]	[in]	[in]	[in]	[in]
	1/12 to 3/8	1/2	0.63	3.74	2.24	2.36	0.63	2.44 × 1.65
	1/2	1/2	0.63	3.74	2.24	2.36	0.63	2.44 × 1.65
Length = (2 × L) + 3.39 in Grounding rings are not necessary.								

Clamp connections

With aseptic molded seal

Tri-Clamp for L14 AM7 1.4404 (316L) Order code for "Process connection", option FAS						
	DN	Suitable for pipe OD	di	G	L	H × B
	[in]	[in]	[in]	[in]	[in]	[in]
	1/12 to 3/8	1/2	0.37	1	1.12	2.44 × 1.65
	1/2	3/4	0.62	25	1.12	2.44 × 1.65
	1	1	0.87	2	1.12	2.83 × 2.17
Length = (2 × L) + 3.39 in Please note the internal diameters of the measuring tube and process connection (di) when cleaning with pigs.						

Clamp according to ISO 2852, Fig. 2 1.4404 (316L) Order code for "Process connection", option IBS							
	DN	Suitable for pipe ISO 2037/BS 4825-1	DN Clamp ISO 2852	di	G	L	H × B
	[in]	[in]	[in]	[in]	[in]	[in]	[in]
	1/2"	0.96 × 0.06	1	0.89	2.00	1.74	2.83 × 2.17
	3/4"	0.96 × 0.06	1	0.89	2.00	1.74	2.83 × 2.17
	1	0.96 × 0.06	1	0.89	2.00	1.74	2.83 × 2.17
Length = (2 × L) + 3.39 in Please note the internal diameters of the measuring tube and process connection (di) when cleaning with pigs.							

Cable glands

Threaded adapter with O-ring seal

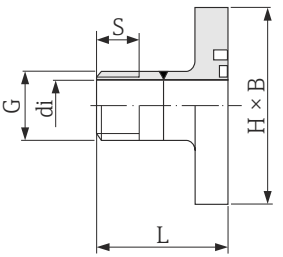
External thread according to ISO 228/DIN 2999 1.4404 (316L) Order code for "Process connection", option I2S							
	DN	Suitable for internal thread ISO 228 / DIN 2999	di	G	L	S	H × B
	[in]	[in]	[in]	[in]	[in]	[in]	[in]
 <p>A0005563</p>	1/12 to 3/8	R 3/8	0.39	3/8	1.57	0.40	2.44 × 1.65
	1/2	R 1/2	0.63	1/2	1.57	0.52	2.44 × 1.65
	1	R 1	0.98	1	1.65	0.655	2.83 × 2.17
Length = (2 × L) + 3.39 in							

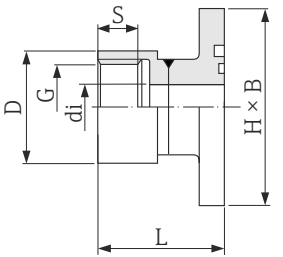
Internal thread according to ISO 228/DIN 2999 1.4404 (316L) Order code for "Process connection", option I3S								
	DN	Suitable for external thread ISO 228 / DIN 2999	di	G	D	L	S	H × B
	[in]	[in]	[in]	[in]	[in]	[in]	[in]	[in]
 <p>A0005565</p>	1/12 to 3/8	Rp 3/8	0.35	3/8	0.87	1.77	0.51	2.44 × 1.65
	1/2	Rp 1/2	0.63	1/2	1.06	1.77	0.55	2.44 × 1.65
	1	Rp 1	1.07	1	1.57	2.01	0.67	2.83 × 2.17
Length = (2 × L) + 3.39 in								

Threaded adapter with aseptic molded seal

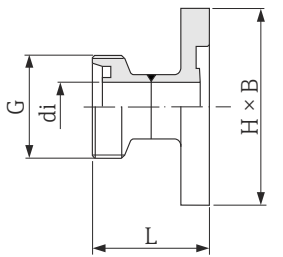
Coupling SC DIN 11851, threaded adapter 1.4404 (316L) Order code for "Process connection", option DCS						
	DN	Suitable for pipe EN 10357 (DIN 11850)	di	G	L	H × B
	[in]	[in]	[in]	[in]	[in]	[in]
 <p>A0005553</p>	1/2	Pipe ODT 3/4	0.63	Rd 0.05 × 0.13	1.73	2.44 × 1.65
	Length = (2 × L) + 3.39 in Please note the internal diameters of the measuring tube and process connection (di) when cleaning with pigs.					

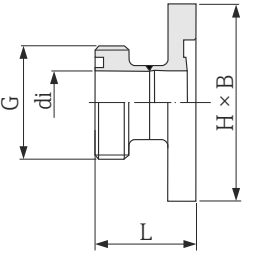
Coupling SMS 1145, threaded adapter 1.4404 (316L) Order code for "Process connection", option SAS							
	DN	Suitable for pipe OD	DN SMS 1145	di	G	L	H × B
	[in]	[in]	[in]	[in]	[in]	[in]	[in]
 <p style="text-align: right; font-size: small;">A0005564</p>	1	1	1	0.89	Rd1.57 × 0.17	1.21	2.83 × 2.17
	Length = (2 × L) + 3.39 in Please note the internal diameters of the measuring tube and process connection (di) when cleaning with pigs.						

Weld-in nipple

With O-ring seal

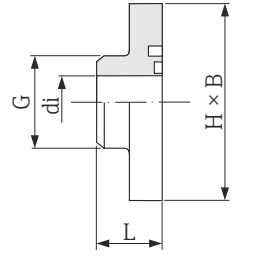
Weld-in nipple according to ODT/SMS 1.4404 (316L) Order code for "Process connection", option A2S						
	DN	Suitable for pipe ODT/SMS	di	G	L	H × B
	[in]	[in]	[in]	[in]	[in]	[in]
 <p style="text-align: right; font-size: small;">A0005548</p>	1/12 to 3/8	0.53 × 0.09	0.35	0.53	0.80	2.44 × 1.65
	1/2	0.84 × 0.10	0.63	0.84	0.80	2.44 × 1.65
	Length = (2 × L) + 3.39 in					

With aseptic molded seal

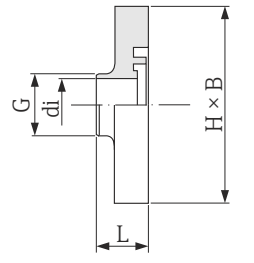
Weld-in nipple according to ISO 2037 1.4404 (316L) Order code for "Process connection", option IAS						
	DN	Suitable for pipe ISO 2037	di	G	L	H × B
	[in]	[in]	[in]	[in]	[in]	[in]
 <p style="text-align: right; font-size: small;">A0003871</p>	1/12 to 3/8	0.50 × 0.06	0.35	0.50	0.63	2.44 × 1.65
	1/2	0.75 × 0.06	0.63	0.75	0.63	2.44 × 1.65
	1	1.00 × 0.06	0.89	1.00	0.63	2.83 × 2.17
	Length = (2 × L) + 3.39 in Please note the internal diameters of the measuring tube and process connection (di) when cleaning with pigs.					

**Weld-in nipple according to ASME BPE
1.4404 (316L)**

Order code for "Process connection", option AAS

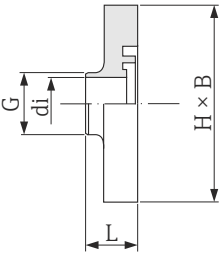
	DN [in]	Suitable for pipe ASME BPE [in]	di [in]	G [in]	L [in]	H × B [in]
 <p>A0003871</p>	1/12 to 3/8	0.50 × 0.06	0.35	0.50	0.63	2.44 × 1.65
	1/2	0.75 × 0.06	0.63	0.75	0.63	2.44 × 1.65
	1	1.00 × 0.06	0.89	1.00	0.63	2.83 × 2.17

Length = (2 × L) + 3.39 in
Please note the internal diameters of the measuring tube and process connection (di) when cleaning with pigs.

Hose adapter

Adhesive sleeves

With O-ring seal

**Adhesive sleeve
PVC**

Order code for "Process connection", options O1V, O2V

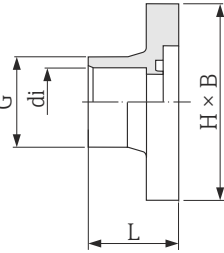
	DN [in]	Suitable for pipe [in]	di [in]	G [in]	L [in]	H × B [in]
 <p>A0005566</p>	1/12 to 3/8	1/2	0.85	1.07	1.52	2.44 × 1.65

Length = (2 × L) + 3.39 in
The required grounding rings can be ordered as accessories (order code: DK5HR-****).

Mountings sets

Wall mounting kit

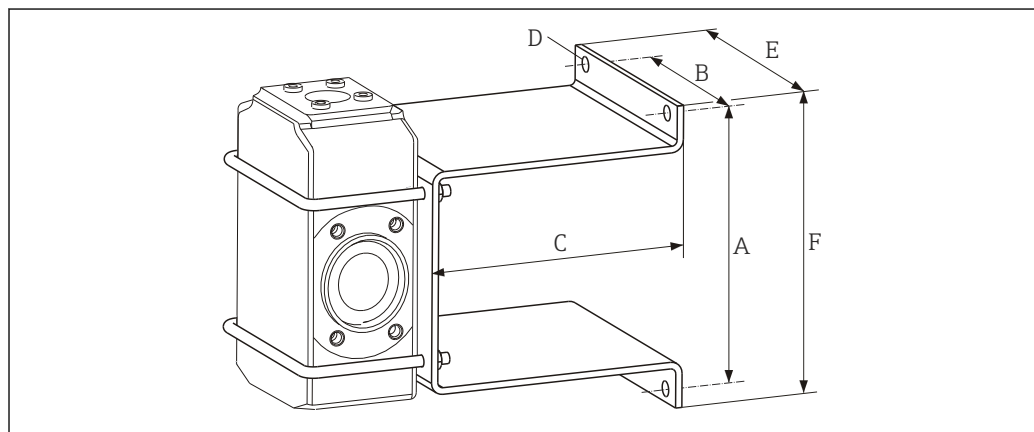

A	B	C	Ø D	E	F
[in]	[in]	[in]	[in]	[in]	[in]
4.92	3.46	4.72	0.28	4.33	5.51

Accessories

Threaded adapters with O-ring seal available for order

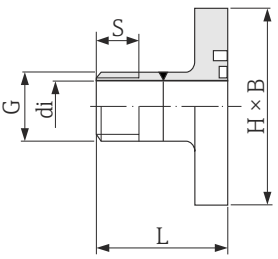
External thread 1.4404 (316L) Order code: DKH**-GD**							
	DN	Suitable for internal thread NP	di	G	L	S	H × B
	[in]	[in]	[in]	[in]	[in]	[in]	[in]
 <p>A0005563</p>	1/12 to 3/8	NPT 3/8	0.39	3/8	2	0.61	2.44 × 1.65
	1/2	NPT 1/2	0.63	1/2	2	0.79	2.44 × 1.65
	1	NPT 1	1	1	2.17	1	2.83 × 2.17
Length = (2 × L) + 3.39 in							

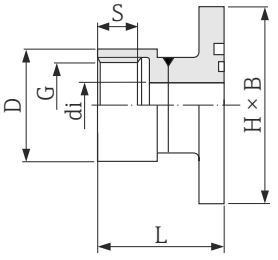
Internal thread 1.4404 (316L) Order code: DKH**-GC**								
	DN	Suitable for external thread NP	di	G	D	L	S	H × B
	[in]	[in]	[in]	[in]	[in]	[in]	[in]	[in]
 <p>A0005565</p>	1/12 to 3/8	NPT 3/8	0.35	3/8	0.87	1.77	0.51	2.44 × 1.65
	1/2	NPT 1/2	0.63	1/2	1.06	1.77	0.55	2.44 × 1.65
	1	NPT 1	1.07	1	1.57	2.01	0.67	2.83 × 2.17
Length = (2 × L) + 3.39 in								

Clamp connections with aseptic molded seal available for order

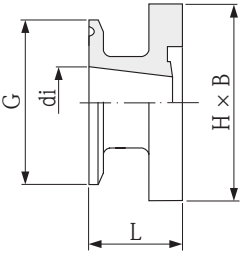
Tri-Clamp for L14 AM17 1.4404 (316L) Order code: DKH**-HF**						
	DN [in]	Suitable for pipe OD [in]	di [in]	G [in]	L [in]	H × B [in]
 <p>A0005555</p>	½	Pipe ODT 1	0.87	2	1.12	2.44 × 1.65
	Length = (2 × L) + 3.39 in Please note the internal diameters of the measuring tube and process connection (di) when cleaning with pigs.					

Grounding rings

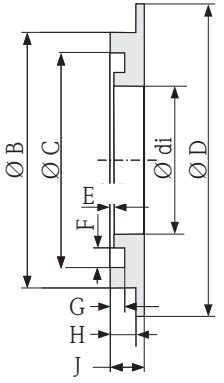
For lap joint flange made of PVDF and PVC adhesive sleeve 1.4435 (316L), Alloy C22, tantalum Order code: DK5HR-****										
	DN [in]	di [in]	B [in]	C [in]	D [in]	E [in]	F [in]	G [in]	H [in]	J [in]
 <p>A0017673</p>	½ to ¾	0.35	0.87	0.69	1.33	0.02	0.14	0.07	0.13	0.18
	½	0.63	1.14	0.97	1.33	0.02	0.14	0.07	0.13	0.18
	1	0.89	1.44	1.23	1.73	0.02	0.14	0.07	0.13	0.18

Weight

Compact version

- Including the transmitter (1.9 kg (4.2 lbs))
- Weight specifications apply to standard pressure ratings and without packaging material.

Nominal diameter		Weight	
[mm]	[in]	[kg]	[lbs]
2	½ ₁₂	3.7	8.2
4	½ ₈	3.7	8.2
8	¾ ₈	3.8	8.4
15	½	3.9	8.6
25	1	4.0	8.8

Measuring tube specification

Nominal diameter		Pressure rating ¹⁾ EN (DIN) [bar]	Process connection internal diameter	
[mm]	[in]		PFA	
			[mm]	[in]
2	1/12	PN 16/40	2.25	0.09
4	1/8	PN 16/40	4.5	0.18
8	3/8	PN 16/40	9.0	0.35
15	½	PN 16/40	16.0	0.63
-	1	PN 16/40	22.6	0.89
25	-	PN 16/40	26.0	1.02

1) Depending on process connection and seals used

Materials

Transmitter housing

- Order code for "Housing", option **C** "Compact, aluminum coated":
Aluminum, AlSi10Mg, coated
- Window material: glass

Cable entries/cable glands

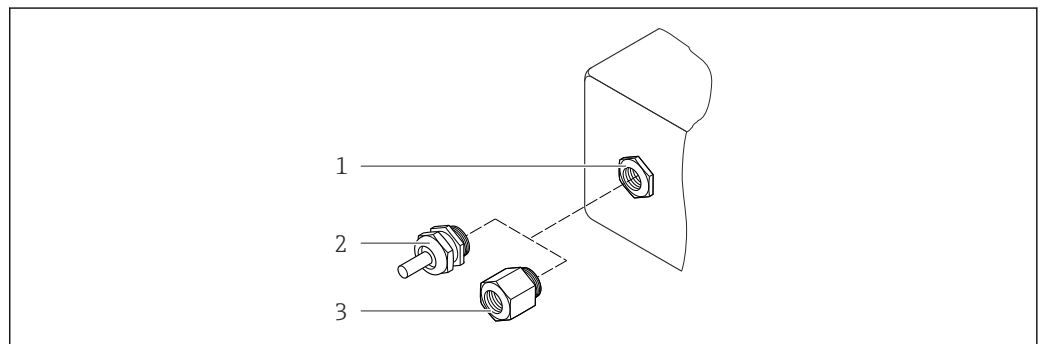

A0020640

21 Possible cable entries/cable glands

- 1 Cable entry in transmitter housing with internal thread M20 x 1.5
- 2 Cable gland M20 x 1.5
- 3 Adapter for cable entry with internal thread G ½" or NPT ½"

Order code for "Housing", option C "GT20 two-chamber, aluminum coated"

Cable entry/cable gland	Type of protection	Material
Cable gland M20 × 1.5	<ul style="list-style-type: none"> ■ Non-Ex ■ Ex ia ■ Ex ic 	Plastic
	Adapter for cable entry with internal thread G ½"	Nickel-plated brass
Adapter for cable entry with internal thread NPT ½"	For non-Ex and Ex (except for CSA Ex d/XP)	Nickel-plated brass
Thread NPT ½" via adapter	For non-Ex and Ex	

Device plug

Electrical connection	Material
Plug M12x1	<ul style="list-style-type: none"> ■ Socket: stainless steel, 1.4401/316 ■ Contact housing: plastic, PUR, black ■ Contacts: metal, CuZn, gold-plated ■ Threaded connection seal: NBR

Sensor housing

Stainless steel 1.4301 (304)

Measuring tubes

Stainless steel 1.4301 (304)

Liner

PFA (USP Class VI, FDA 21 CFR 177.1550, 3A)

Process connections

- Stainless steel 1.4404 (F316L)
- PVDF
- PVC adhesive sleeve

Electrodes

- Standard: 1.4435 (316L)
- Optional: Alloy C22, tantalum, platinum

Seals

- O-ring seal: EPDM, FKM, Kalrez
- Aseptic molded seal: EPDM¹⁾, FKM, silicone¹⁾

Accessories*Weather protection cover*

Stainless steel 1.4404 (316L)

Grounding rings

- Standard: 1.4435 (F316L)
- Optional: Alloy C22, tantalum

Wall mounting kit

Stainless steel 1.4301 (304)

Fitted electrodesMeasuring electrodes and empty pipe detection electrodes (only DN 25 (1")):
1.4435 (316L), Alloy C22, platinum, tantalum**Process connections**

- With O-ring seal
- Weld-in nipple (DIN EN ISO 1127, ODT/SMS, ISO 2037)
 - Flange (EN (DIN), ASME, JIS)
 - Flange from PVDF (EN (DIN), ASME, JIS)
 - External thread
 - Internal thread
 - Hose connection
 - PVC adhesive sleeve

1) USP Class VI, FDA 21 CFR 177.2600, 3A

With aseptic molded seal:

- Weld-in nipple (EN 10357 (DIN 11850), ODT/SMS, ISO 2037)
- Clamp (ISO 2852, DIN 32676, L14 AM7)
- Coupling (DIN 11851, DIN 11864-1, ISO 2853, SMS 1145)
- Flange DIN 11864-2

 For information on the materials of the process connections →  58

Surface roughness

Stainless steel electrodes, 1.4435 (F316L); Alloy C22, 2.4602 (UNS N06022); platinum; tantalum:
 ≤ 0.3 to 0.5 µm (11.8 to 19.7 µin)
 (All data relate to parts in contact with fluid)

Liner with PFA:
 ≤ 0.4 µm (15.7 µin)
 (All data relate to parts in contact with fluid)

Stainless steel process connections:
 ≤ 0.8 µm (31 µin)
 (All data relate to parts in contact with fluid)

Operability

Operating concept

Operator-oriented menu structure for user-specific tasks

- Commissioning
- Operation
- Diagnostics
- Expert level

Quick and safe commissioning

- Guided menus ("Make-it-run" wizards) for applications
- Menu guidance with brief explanations of the individual parameter functions

Reliable operation

- Operation in the following languages:
 - Via local display: English, German, French, Spanish, Italian, Dutch, Portuguese, Polish, Russian, Swedish, Turkish, Chinese, Japanese, Bahasa (Indonesian), Vietnamese, Czech
 - Via "FieldCare" operating tool: English, German, French, Spanish, Italian, Chinese, Japanese
- Uniform operating philosophy applied to device and operating tools
- If replacing the electronic module, transfer the device configuration via the integrated memory (integrated HistoROM) which contains the process and measuring device data and the event logbook. No need to reconfigure.

Efficient diagnostics increase measurement availability

- Troubleshooting measures can be called up via the device and in the operating tools
- Diverse simulation options, logbook for events that occur and optional line recorder functions

Local operation

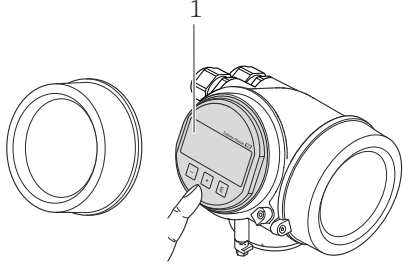
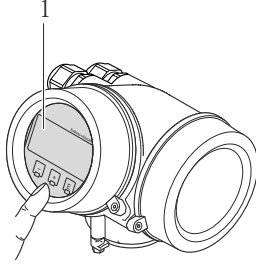

Via display module

Order code for "Display; Operation", option C "SD02"	Order code for "Display; Operation", option E "SD03"
 <p style="text-align: right; font-size: small;">A0015544</p>	 <p style="text-align: right; font-size: small;">A0015546</p>
<p>1 <i>Operation with pushbuttons</i></p>	<p>1 <i>Operation with touch control</i></p>

Display elements

- 4-line display
- With order code for "Display; operation", option **E**:
White background lighting; switches to red in event of device errors
- Format for displaying measured variables and status variables can be individually configured
- Permitted ambient temperature for the display: -20 to +60 °C (-4 to +140 °F)
The readability of the display may be impaired at temperatures outside the temperature range.

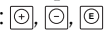
Operating elements

- With order code for "Display; operation", option **C**:
Local operation with 3 push buttons: 
- With order code for "Display; operation", option **E**:
External operation via touch control; 3 optical keys: 
- Operating elements also accessible in various hazardous areas

Additional functionality

- Data backup function
The device configuration can be saved in the display module.
- Data comparison function
The device configuration saved in the display module can be compared to the current device configuration.
- Data transfer function
The transmitter configuration can be transmitted to another device using the display module.

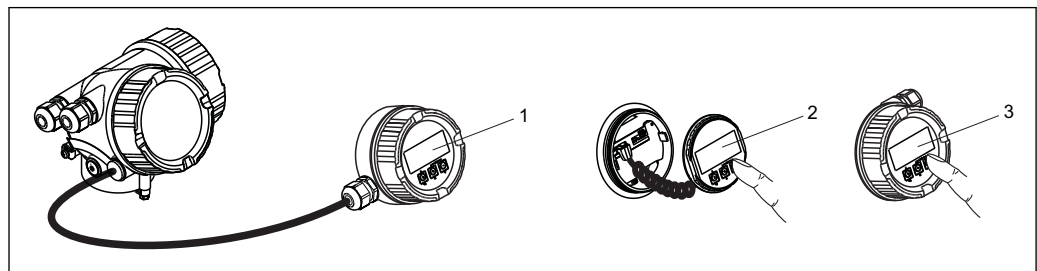
Via remote display and operating module FHX50

A0013137

 22 Operating options via FHX50

- 1 Housing of remote display and operating module FHX50
- 2 SDO2 display and operating module, push buttons: cover must be opened for operation
- 3 SDO3 display and operating module, optical buttons: operation possible through cover glass

Remote operation**Via HART protocol**

This communication interface is available in device versions with a HART output.

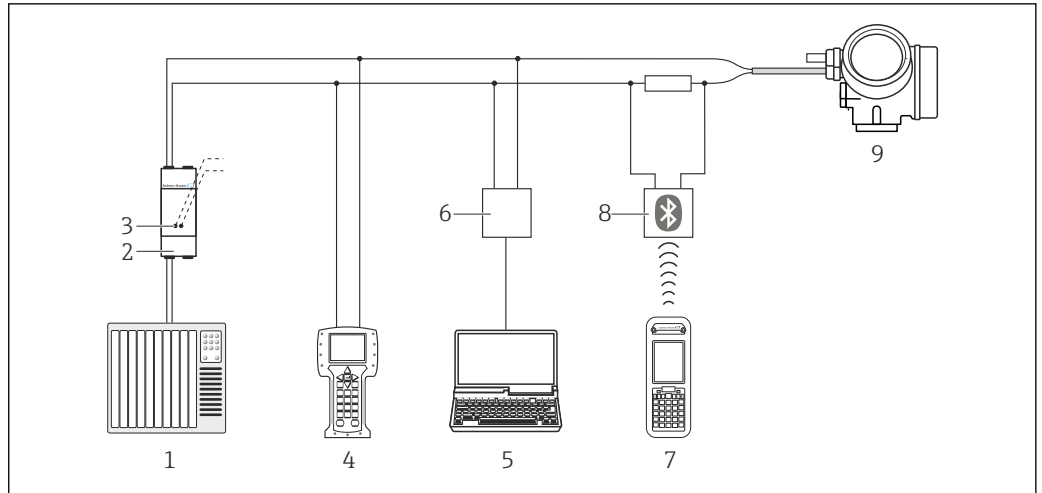

A0013764

23 Options for remote operation via HART protocol

- 1 Control system (e.g. PLC)
- 2 Transmitter power supply unit, e.g. RN221N (with communication resistor)
- 3 Connection for Commubox FXA195 and Field Communicator 475
- 4 Field Communicator 475
- 5 Computer with operating tool (e.g. FieldCare, AMS Device Manager, SIMATIC PDM)
- 6 Commubox FXA195 (USB)
- 7 Field Xpert SFX350 or SFX370
- 8 VIATOR Bluetooth modem with connecting cable
- 9 Transmitter

Via PROFIBUS PA network

This communication interface is available in device versions with PROFIBUS PA.

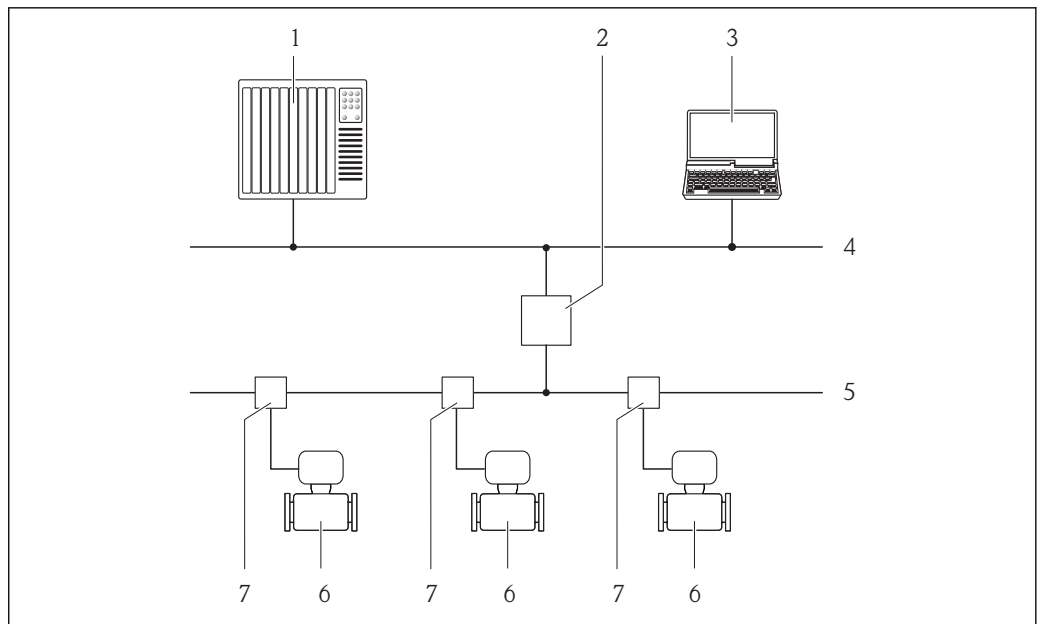

A0019013

24 Options for remote operation via PROFIBUS PA network

- 1 Automation system
- 2 Segment coupler PROFIBUS DP/PA
- 3 Computer with PROFIBUS network card
- 4 PROFIBUS DP network
- 5 PROFIBUS PA network
- 6 Measuring device
- 7 T-box

Via FOUNDATION Fieldbus network

This communication interface is available in device versions with FOUNDATION Fieldbus.

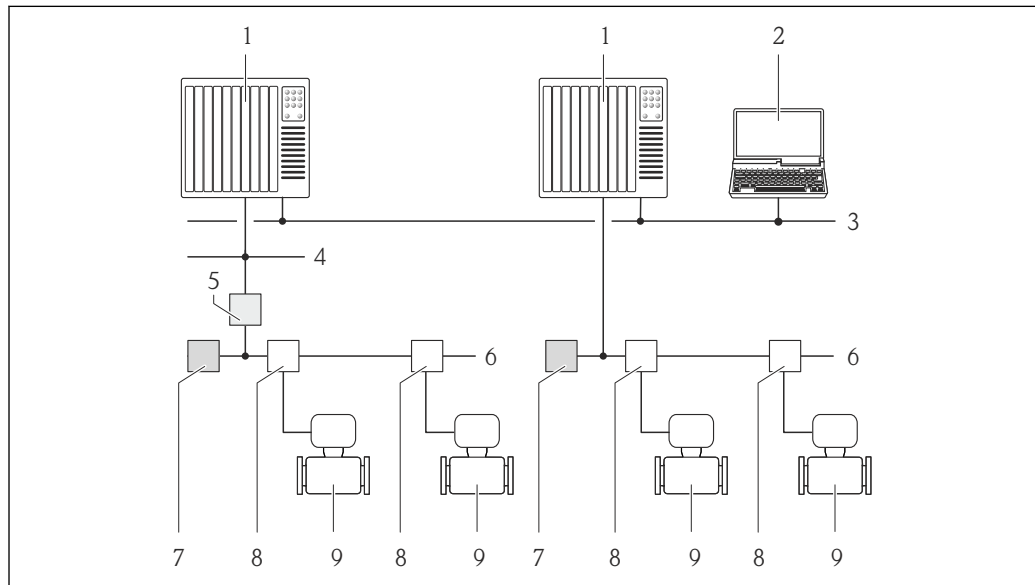

A0023460

25 Options for remote operation via FOUNDATION Fieldbus network

- 1 Automation system
- 2 Computer with FOUNDATION Fieldbus network card
- 3 Industry network
- 4 High Speed Ethernet FF-HSE network
- 5 Segment coupler FF-HSE/FF-H1
- 6 FOUNDATION Fieldbus FF-H1 network
- 7 Power supply FF-H1 network
- 8 T-box
- 9 Measuring device

Service interface

Via service interface (CDI)

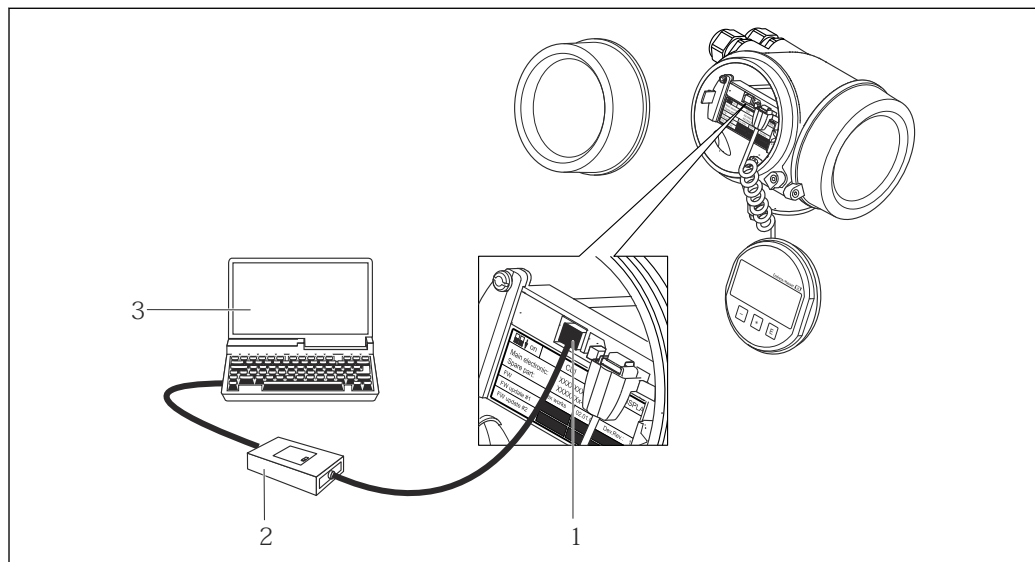

A0014019

- 1 Service interface (CDI = Endress+Hauser Common Data Interface) of the measuring device
- 2 Commubox FXA291
- 3 Computer with "FieldCare" operating tool with COM DTM "CDI Communication FXA291"

Certificates and approvals

CE mark	<p>The measuring system is in conformity with the statutory requirements of the applicable EC Directives. These are listed in the corresponding EC Declaration of Conformity along with the standards applied.</p> <p>Endress+Hauser confirms successful testing of the device by affixing to it the CE mark.</p>
C-Tick symbol	<p>The measuring system meets the EMC requirements of the "Australian Communications and Media Authority (ACMA)".</p>
Ex approval	<p>The measuring device is certified for use in hazardous areas and the relevant safety instructions are provided in the separate "Safety Instructions" (XA) document. Reference is made to this document on the nameplate.</p> <p> The separate Ex documentation (XA) containing all the relevant explosion protection data is available from your Endress+Hauser sales center.</p>

ATEX, IECEx

Currently, the following versions for use in hazardous areas are available:

Ex d

Category	Type of protection
II2G / Zone 1	Ex d ia IIC T6-T1 Gb
II2D / Zone 21	Ex tb IIIC T** Db

Ex ia

Category	Type of protection
II2G / Zone 1	Ex ia IIC T6-T1 Gb
III2D / Zone 21	Ex tb IIIC T** Db

Ex nA

Category	Type of protection
II3G / Zone 2	Ex nA IIC T6-T1 Gc

Ex ic

Category	Type of protection
II3G / Zone 2	Ex ic IIC T6-T1 Gc

cCSAus

Currently, the following versions for use in hazardous areas are available:

XP

Category	Type of protection
Class I/II/III Division 1 Groups ABCDEFG	XP (Ex d Flameproof version)

IS

Category	Type of protection
Class I/II/III Division 1 Groups ABCDEFG	IS (Ex i Intrinsically safe version), Entity parameter ¹⁾

1) Entity and NIFW parameter in accordance with Control Drawings

NI

Category	Type of protection
Class I Division 2 Groups ABCD	NI (Non-incendive version), NIFW parameter ¹⁾

1) Entity and NIFW parameter in accordance with Control Drawings

Sanitary compatibility

- 3A approval and EHEDG-certified
- Seals → in conformity with FDA (apart from Kalrez seals)

Functional safety

The measuring device can be used for flow monitoring systems (min., max., range) up to SIL 2 (single-channel architecture) and SIL 3 (multichannel architecture with homogeneous redundancy) and is independently evaluated and certified by the TÜV in accordance with IEC 61508.

The following types of monitoring in safety equipment are possible:

Volume flow



Functional Safety Manual with information on the SIL device → 69

HART certification**HART interface**

The measuring device is certified and registered by the HCF (HART Communication Foundation). The measuring system meets all the requirements of the following specifications:

- Certified according to HART 7
- The device can also be operated with certified devices of other manufacturers (interoperability)

FOUNDATION Fieldbus certification**FOUNDATION Fieldbus interface**

The measuring device is certified and registered by the Fieldbus FOUNDATION. The measuring system meets all the requirements of the following specifications:

- Certified in accordance with FOUNDATION Fieldbus H1
- Interoperability Test Kit (ITK), revision version 6.1.1 (certificate available on request)
- Physical Layer Conformance Test
- The device can also be operated with certified devices of other manufacturers (interoperability)

Certification PROFIBUS**PROFIBUS interface**

The measuring device is certified and registered by the PROFIBUS User Organization (PNO). The measuring system meets all the requirements of the following specifications:

- Certified in accordance with PROFIBUS PA Profile 3.02
- The device can also be operated with certified devices of other manufacturers (interoperability)

Other standards and guidelines

- EN 60529
Degrees of protection provided by enclosures (IP code)
- EN 61010-1
Safety requirements for electrical equipment for measurement, control and laboratory use
- IEC/EN 61326
Emission in accordance with Class A requirements. Electromagnetic compatibility (EMC requirements).
- ANSI/ISA-61010-1 (82.02.01): 2004
Safety Requirements for Electrical Equipment for Measurement, Control and Laboratory Use - Part 1 General Requirements
- CAN/CSA-C22.2 No. 61010-1-04
Safety Requirements for Electrical Equipment for Measurement, Control and Laboratory Use - Part 1 General Requirements
- NAMUR NE 21
Electromagnetic compatibility (EMC) of industrial process and laboratory control equipment
- NAMUR NE 32
Data retention in the event of a power failure in field and control instruments with microprocessors
- NAMUR NE 43
Standardization of the signal level for the breakdown information of digital transmitters with analog output signal.
- NAMUR NE 53
Software of field devices and signal-processing devices with digital electronics

- NAMUR NE 105
Specifications for integrating fieldbus devices in engineering tools for field devices
- NAMUR NE 107
Self-monitoring and diagnosis of field devices
- NAMUR NE 131
Requirements for field devices for standard applications

Ordering information

Detailed ordering information is available from the following sources:

- In the Product Configurator on the Endress+Hauser website: www.endress.com → Select your country → Products → Select measuring technology, software or components → Select the product (picklists: measurement method, product family etc.) → Device support (right-hand column): Configure the selected product → The Product Configurator for the selected product opens.
- From your Endress+Hauser Sales Center: www.addresses.endress.com



Product Configurator - the tool for individual product configuration

- Up-to-the-minute configuration data
- Depending on the device: Direct input of measuring point-specific information such as measuring range or operating language
- Automatic verification of exclusion criteria
- Automatic creation of the order code and its breakdown in PDF or Excel output format
- Ability to order directly in the Endress+Hauser Online Shop

Application packages

Many different application packages are available to enhance the functionality of the device. Such packages might be needed to address safety aspects or specific application requirements.

The application packages can be ordered with the device or subsequently from Endress+Hauser. Detailed information on the order code in question is available from your local Endress+Hauser sales center or on the product page of the Endress+Hauser website: www.endress.com.

Diagnostics functions

Package	Description
HistoROM extended function	<p>Comprises extended functions concerning the event log and the activation of the measured value memory.</p> <p>Event log: Memory volume is extended from 20 message entries (basic version) to up to 100 entries.</p> <p>Data logging (line recorder):</p> <ul style="list-style-type: none"> ■ Memory capacity for up to 1000 measured values is activated. ■ 250 measured values can be output via each of the 4 memory channels. The recording interval can be defined and configured by the user. ■ Data logging is visualized via the local display or FieldCare.

Heartbeat Technology

Package	Description
Heartbeat Verification	<p>Heartbeat Verification: Makes it possible to check the device functionality on demand when the device is installed, without having to interrupt the process.</p> <ul style="list-style-type: none"> ■ Access via local operation or other operating interfaces, such as FieldCare for instance. ■ Documentation of device functionality within the framework of manufacturer specifications, for proof testing for instance. ■ End-to-end, traceable documentation of the verification results, including report. ■ Makes it possible to extend calibration intervals in accordance with operator's risk assessment.





Accessories

Various accessories, which can be ordered with the device or subsequently from Endress+Hauser, are available for the device. Detailed information on the order code in question is available from your local Endress+Hauser sales center or on the product page of the Endress+Hauser website:

www.endress.com.

Device-specific accessories

For the transmitter









Accessories	Description
Remote display FHX50	<p>FHX50 housing to accommodate a display module →  60.</p> <ul style="list-style-type: none"> ■ FHX50 housing suitable for: <ul style="list-style-type: none"> – SD02 display module (push buttons) – SD03 display module (touch control) ■ Housing material: <ul style="list-style-type: none"> – Plastic PBT – Stainless steel CF-3M (316L, 1.4404) ■ Length of connecting cable: up to max. 60 m (196 ft) (cable lengths available for order: 5 m (16 ft), 10 m (32 ft), 20 m (65 ft), 30 m (98 ft)) <p>The measuring device can be ordered with the FHX50 housing and a display module. The following options must be selected in the separate order codes:</p> <ul style="list-style-type: none"> ■ Order code for measuring device, feature 030: Option L or M "Prepared for FHX50 display" ■ Order code for FHX50 housing, feature 050 (device version): Option A "Prepared for FHX50 display" ■ Order code for FHX50 housing, depends on the desired display module in feature 020 (display, operation): <ul style="list-style-type: none"> – Option C: for an SD02 display module (push buttons) – Option E: for an SD03 display module (touch control) <p>The FHX50 housing can also be ordered as a retrofit kit. The measuring device display module is used in the FHX50 housing. The following options must be selected in the order code for the FHX50 housing:</p> <ul style="list-style-type: none"> ■ Feature 050 (measuring device version): option B "Not prepared for FHX50 display" ■ Feature 020 (display, operation): option A "None, existing displayed used" <p> For details, see Special Documentation SD01007F</p>
Overvoltage protection for 2-wire devices	<p>Ideally, the overvoltage protection module should be ordered directly with the device. See product structure, characteristic 610 "Accessory mounted", option NA "Overvoltage protection". Separate order necessary only if retrofitting.</p> <ul style="list-style-type: none"> ■ OVP10: For 1-channel devices (characteristic 020, option A): ■ OVP20: For 2-channel devices (characteristic 020, options B, C, E or G) <p> For details, see Special Documentation SD01090F.</p>
Weather protection cover	<p>Is used to protect the measuring device from the effects of the weather: e.g. rainwater, excess heating from direct sunlight or extreme cold in winter.</p> <p> For details, see Special Documentation SD00333F</p>

For the sensor

Accessories	Description
Seal set	For the regular replacement of seals for the sensor.
Welding jig	Welded connection as process connection: welding jig for installation in pipe.

Grounding rings	<p>Are used to ground the fluid in lined measuring tubes to ensure proper measurement.</p> <p> For details, see Installation Instructions EA00070D</p>
Mounting kit	<p>Consists of:</p> <ul style="list-style-type: none"> ▪ 2 process connections ▪ Screws ▪ Seals

Communication-specific accessories



Accessories	Description
Commubox FXA195 HART	<p>For intrinsically safe HART communication with FieldCare via the USB interface.</p> <p> For details, see "Technical Information" TI00404F</p>
Commubox FXA291	<p>Connects Endress+Hauser field devices with a CDI interface (= Endress+Hauser Common Data Interface) and the USB port of a computer or laptop.</p> <p> For details, see the "Technical Information" document TI405C/07</p>
HART Loop Converter HMX50	<p>Is used to evaluate and convert dynamic HART process variables to analog current signals or limit values.</p> <p> For details, see "Technical Information" TI00429F and Operating Instructions BA00371F</p>
Wireless HART adapter SWA70	<p>Is used for the wireless connection of field devices. The WirelessHART adapter can be easily integrated into field devices and existing infrastructures, offers data protection and transmission safety and can be operated in parallel with other wireless networks with minimum cabling complexity.</p> <p> For details, see Operating Instructions BA00061S</p>
Fieldgate FXA320	<p>Gateway for the remote monitoring of connected 4-20 mA measuring devices via a Web browser.</p> <p> For details, see "Technical Information" TI00025S and Operating Instructions BA00053S</p>
Fieldgate FXA520	<p>Gateway for the remote diagnostics and remote configuration of connected HART measuring devices via a Web browser.</p> <p> For details, see "Technical Information" TI00025S and Operating Instructions BA00051S</p>
Field Xpert SFX350	<p>Field Xpert SFX350 is a mobile computer for commissioning and maintenance. It enables efficient device configuration and diagnostics for HART and FOUNDATION Fieldbus devices in the non-Ex area.</p> <p> For details, see Operating Instructions BA01202S</p>
Field Xpert SFX370	<p>Field Xpert SFX370 is a mobile computer for commissioning and maintenance. It enables efficient device configuration and diagnostics for HART and FOUNDATION Fieldbus devices in the non-Ex area and the Ex area.</p> <p> For details, see Operating Instructions BA01202S</p>

Service-specific accessories

Accessories	Description
Applicator	<p>Software for selecting and sizing Endress+Hauser measuring devices:</p> <ul style="list-style-type: none"> ▪ Calculation of all the data needed to determine the optimum flowmeter: e.g. nominal diameter, pressure drop, performance characteristics or process connections. ▪ Graphic illustration of the calculation results <p>Administration, documentation and access to all project-related data and parameters throughout the entire life cycle of a project.</p> <p>Applicator is available:</p> <ul style="list-style-type: none"> ▪ Via the Internet: https://wapps.endress.com/applicator ▪ On CD-ROM for local PC installation.

W@M	<p>Life cycle management for your plant</p> <p>W@M supports you with a wide range of software applications over the entire process: from planning and procurement, to the installation, commissioning and operation of the measuring devices. All the relevant information is available for every measuring device over time entire life cycle, such as the device status, spare parts, device-specific documentation, etc.</p> <p>The application already contains the data of your Endress+Hauser device. Endress+Hauser also takes care of maintaining and updating the data records.</p> <p>W@M is available:</p> <ul style="list-style-type: none"> ■ Via the Internet: www.endress.com/lifecyclemanagement ■ On CD-ROM for local PC installation.
FieldCare	<p>FDT-based plant asset management tool from Endress+Hauser.</p> <p>It can configure all smart field units in your system and helps you manage them. By using the status information, it is also a simple but effective way of checking their status and condition.</p> <p> For details, see Operating Instructions BA00027S and BA00059S</p>

System components

Accessories	Description
Memograph M graphic display recorder	<p>The Memograph M graphic display recorder provides information on all relevant measured variables. Measured values are recorded correctly, limit values are monitored and measuring points analyzed. The data are stored in the 256 MB internal memory and also on a SD card or USB stick.</p> <p> For details, see "Technical Information" TI00133R and Operating Instructions BA00247R</p>
RN221N	<p>Active barrier with power supply for safe separation of 4-20 mA standard signal circuits. Offers bidirectional HART transmission.</p> <p> For details, see "Technical Information" TI00073R and Operating Instructions BA00202R</p>
RNS221	<p>Supply unit for powering two 2-wire measuring devices solely in the non-Ex area. Bidirectional communication is possible via the HART communication jacks.</p> <p> For details, see "Technical Information" TI00081R and Brief Operating Instructions KA00110R</p>

Documentation

-  For an overview of the scope of the associated Technical Documentation, refer to the following:
- The CD-ROM provided for the device (depending on the device version, the CD-ROM might not be part of the delivery!)
 - The *W@M Device Viewer* : Enter the serial number from the nameplate (www.endress.com/deviceviewer)
 - The *Endress+Hauser Operations App*: Enter the serial number from the nameplate or scan the 2-D matrix code (QR code) on the nameplate.

Standard documentation

Brief Operating Instructions

Measuring device	Documentation code
Promag H 200	KA01120D

Operating Instructions

Measuring device	Documentation code		
	HART	FOUNDATION Fieldbus	PROFIBUS PA
Promag H 200	BA01110D	BA01377D	BA01375D

Device Parameters

Measuring device	Documentation code		
	HART	FOUNDATION Fieldbus	PROFIBUS PA
Promag 200	GP01026D	GP01028D	GP01027D

Supplementary device-dependent documentation

Safety Instructions

Contents	Documentation code
ATEX/IECEX Ex d[ia], Ex tb	XA01015D
ATEX/IECEX Ex ia, Ex tb	XA01016D
ATEX/IECEX Ex nA, Ex ic	XA01017D
cCSAus XP (Ex d)	XA01018D
cCSAus IS (Ex i)	XA01019D
NEPSI Ex d	XA01179D
NEPSI Ex i	XA01178D
NEPSI Ex nA, Ex ic	XA01180D
INMETRO Ex d	XA01309D
INMETRO Ex i	XA01310D
INMETRO Ex nA	XA01311D

Special Documentation

Contents	Documentation code
Functional Safety Manual	SD01451D
Heartbeat Technology	SD01452D

Installation Instructions

Contents	Documentation code
Installation Instructions for spare part sets	Specified for each individual accessory

Registered trademarks

HART®

Registered trademark of the HART Communication Foundation, Austin, USA

PROFIBUS®

Registered trademark of the PROFIBUS User Organization, Karlsruhe, Germany

FOUNDATION™ Fieldbus

Registration-pending trademark of the Fieldbus Foundation, Austin, Texas, USA

Applicator®, FieldCare®, Field Xpert™, HistoROM®, Heartbeat Technology™

Registered or registration-pending trademarks of the Endress+Hauser Group

www.addresses.endress.com
